

# 2024 Catalog



Your Network's Edge®



# Table of Contents

<b>Company Profile .....</b>	<b>2</b>
<b>Solutions for Service Providers .....</b>	<b>4</b>

## | Wholesale Services

Wholesale Networking .....	5
----------------------------	---

## | Business Services

Carrier Ethernet for L2 VPNs .....	6
Carrier Ethernet for Direct Internet and Cloud Access .....	7
Smart Diagnostics with AI-Powered Networking .....	8
DDoS Protection at the Edge .....	9
IP Traffic Encryption .....	10
Asset Monitoring with Edge Computing .....	11
IoT over Private 4G/5G Networks .....	12
IoT as a Service for SMBs .....	13
TDM Migration .....	14

## | Mobile Services

4G/5G Mobile xHaul .....	15
Timing Synchronization for Mobile Networks .....	16

<b>Networking Solutions for Critical Infrastructure .....</b>	<b>17</b>
---	-----------

## | Utilities

Smart Grid and Substation Automation .....	18
Asset Monitoring for Power Transmission Towers .....	19
Power Utility Communications: Multiservice Operational WAN .....	20
Oil & Gas Communications .....	21

## | Transportation

Highway Communications .....	22
Operational WAN for Trains and Metros .....	23
Multiservice Operational WAN for Air Traffic Control .....	24

## | Government

Smart City Communications: Asset Monitoring and Operational WAN .....	25
First Responders and Military Communications .....	26

<b>RAD Products .....</b>	<b>27</b>
---------------------------	-----------

<b>RAD Services .....</b>	<b>50</b>
---------------------------	-----------

<b>RADadvantage Partners Program .....</b>	<b>54</b>
--	-----------

# The Expertise to Deliver. The Agility to Customize.

RAD is an industry leader in networking solutions.

Trusted by Tier-1 communication service providers and critical infrastructure operators in over 150 countries, RAD delivers best-of-breed Carrier Edge, industrial IoT, 5G, and critical operational network solutions that ensure always-on connectivity from anywhere.

As an innovation powerhouse for over 40 years, RAD works together with its customers to help them easily navigate digital transformation, as well as monetize their network and move up the value chain.



# RAD's Offering



## Carrier Services, Redefined

---

- Private 5G Connectivity
- IoT as a Service for Business Customers
- Deterministic Carrier Edge



## Industrial Digitalization

---

- Full Stack IoT
- Secure Networking & Automation
- End-to-End Asset Monitoring



## AI-Powered Networking

---

- NaaS at the Edge
- QoE Analytics & Threat Protection





# Service Providers

Redefining carrier services and bringing AI to the network edge.

RAD empowers wholesale, business and mobile service providers to enrich their service portfolios by delivering added value at the network edge for businesses transitioning to the cloud. Our solutions enable Ethernet business connectivity and mobile xHaul. They also support next-generation offerings, such as IoT as a Service and 5G campuses, as well as AI-powered networking for NaaS at the edge, QoE analytics and threat protection.

- Market-leading Carrier Edge portfolio with SLA assurance, end-to-end visibility and life-cycle management over any access
- Ultra-fast service rates and setup with zero-touch automation and LTE/5G broadband uplinks, license-enabled remote upgrades from 1G up to 100G and ruggedized enclosures for outdoor deployments
- Carrier Ethernet for business direct internet and cloud access with E-Access/E-LAN services
- DDoS protection embedded at the network edge
- Smart diagnostics for enhanced quality of experience (QoE), with end-to-end monitoring, AI/ML-based trend analytics and troubleshooting
- Remote asset monitoring with Edge Computing and full stack IoT for upgraded IoT services
- Provide much needed flexibility
- IP traffic encryption providing security using SFP sleeve

# Wholesale Networking

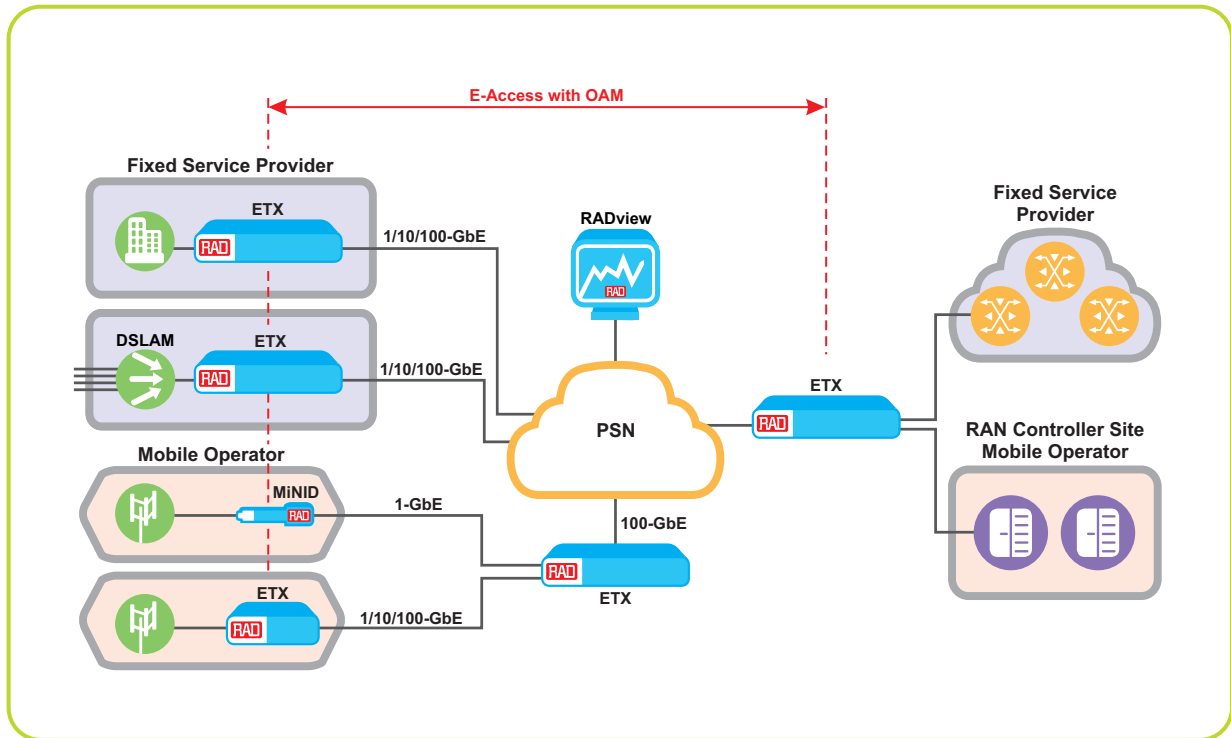

## Your Benefits:

- Provide wholesale Carrier Ethernet transport services to multiple service providers with complete visibility and controlled service hand-off between multiple networks
- Demarcation for business and mobile services, and broadband access node (e.g., PON) backhaul over the same transport network
- Provide SLA-based backhaul all the way to the end-customer site, cell site or POP, using a service assurance toolbox
- MEF-certified (CE 2.0 / MEF 3.0) E-Access support with single-CoS and/or multiple-CoS EVC/OVC for standards-based carrier-to-carrier connectivity
- Seamless connection between networks with 1-GbE, 10-GbE, 25-GbE and 100G E-NNI interfaces with optional redundancy
- Double fiber capacity while avoiding costly new fiber/transceiver deployments with BiDi QSFP 100G adaptors
- Support 5G convergence for wholesale services and L2 FWA



**ETX-2/ETX-2i**  
1/10/25/100G EADs,  
LTE/5G and Broadband  
Options



**MiNID**  
Miniature  
Programmable Network  
Interface Device



**BiDi QSFP Adaptor**  
100G Dual to Single  
Fiber Passive Adaptor



**RADview**  
Management and  
Domain Orchestration

# Carrier Ethernet for L2 VPNs

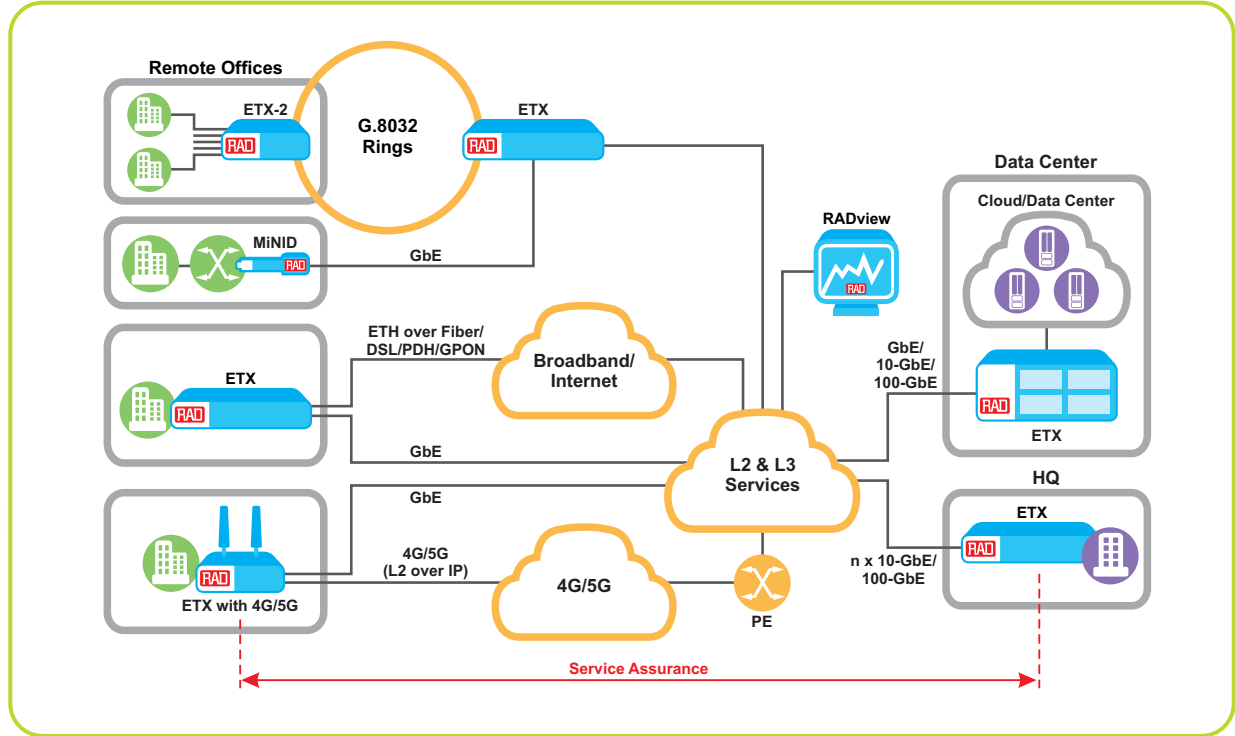

### Your Benefits:

- Easily plan, deploy, provision, and maintain SLA-based business services over any access: fiber/copper/TDM/mobile
- Carrier Ethernet demarcation and aggregation switch up to 1/10/25/100G
- MEF 3.0-certified with standard NETCONF/YANG northbound interfaces
- Cost-effective aggregation with dynamic edge support for monitoring and policing
- Ruggedized enclosure for outdoor installations
- Support L2 fixed-wireless access (FWA)
- Enhanced service provisioning, visibility and reporting using RADview Service Manager and RADview Performance Monitoring portal
- Double fiber capacity while avoiding costly new fiber/transceiver deployments with BiDi QSFP 100G adaptors



**ETX-2/ETX-2i**  
1/10/25/100G EADs,  
LTE/5G and Broadband  
Options



**MiNID**  
Miniature  
Programmable Network  
Interface Device



**BiDi QSFP Adaptor**  
100G Dual to Single  
Fiber Passive Adaptor



**RADview**  
Management and  
Domain Orchestration



# Carrier Ethernet for Direct Internet and Cloud Access

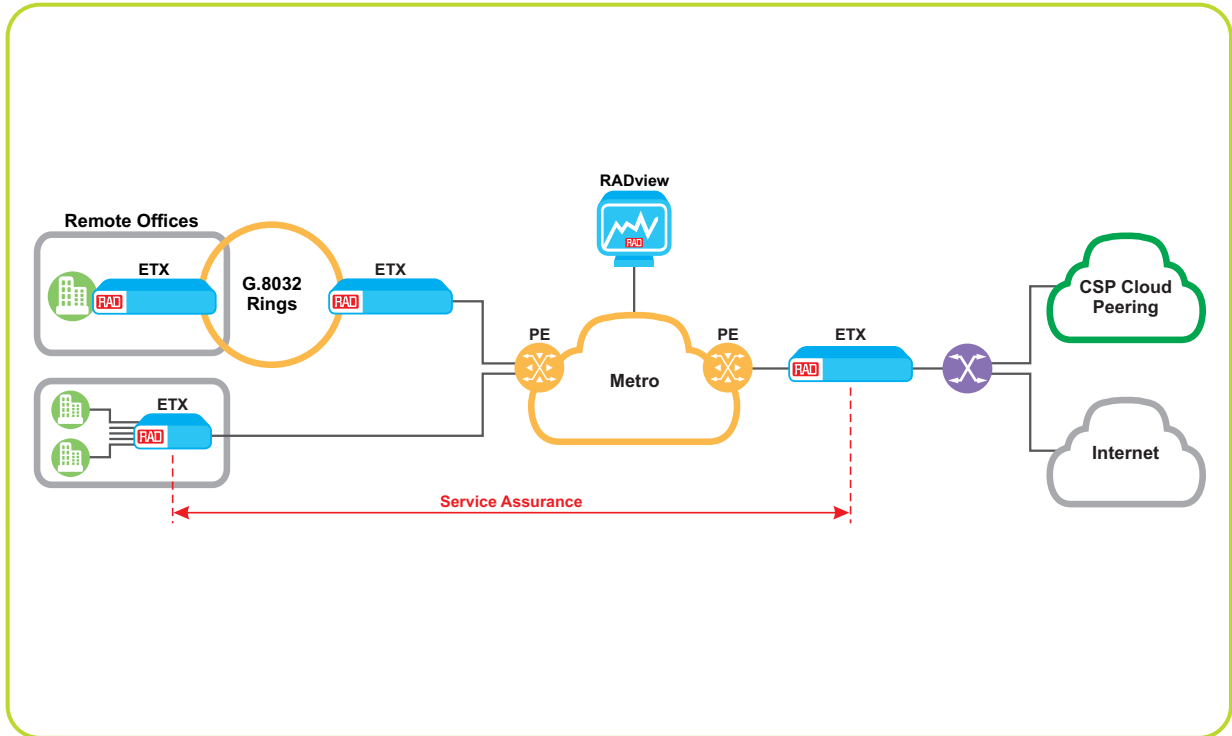

## Your Benefits:

- Direct cloud access for business customers; E-Access/E-LAN service over fiber via the CSP network to the cloud provider
- Single/multi-CoS service addressing business needs for high bandwidth and high quality internet access to public cloud services
  - Avoid unstable internet connections to critical assets on the cloud
- End-to-end, branch to cloud Layer 2 transport with guaranteed SLA
- Central EAD may share multiple customer connections bridging Ethernet transport with cloud peering networks
- Advanced service assurance toolbox for CSP operations
  - Service activation test (Y.1564/RFC-2544)
- Hardware-based OAM for service and performance monitoring
- Zero-touch, NETCONF/YANG support, diagnostic loopbacks, in-service ping, auto R-MEP learning, and additional operations support tools



**ETX-2/ETX-2i**  
1/10/25/100G EADs,  
LTE/5G and Broadband  
Options



**MiNID**  
Miniature  
Programmable Network  
Interface Device



**RADinsight**  
Threat Intelligence at the  
Edge and Smart Diagnostics  
for Enhanced QoE



**RADview**  
Management and  
Domain Orchestration



# Smart Diagnostics with AI-Powered Networking

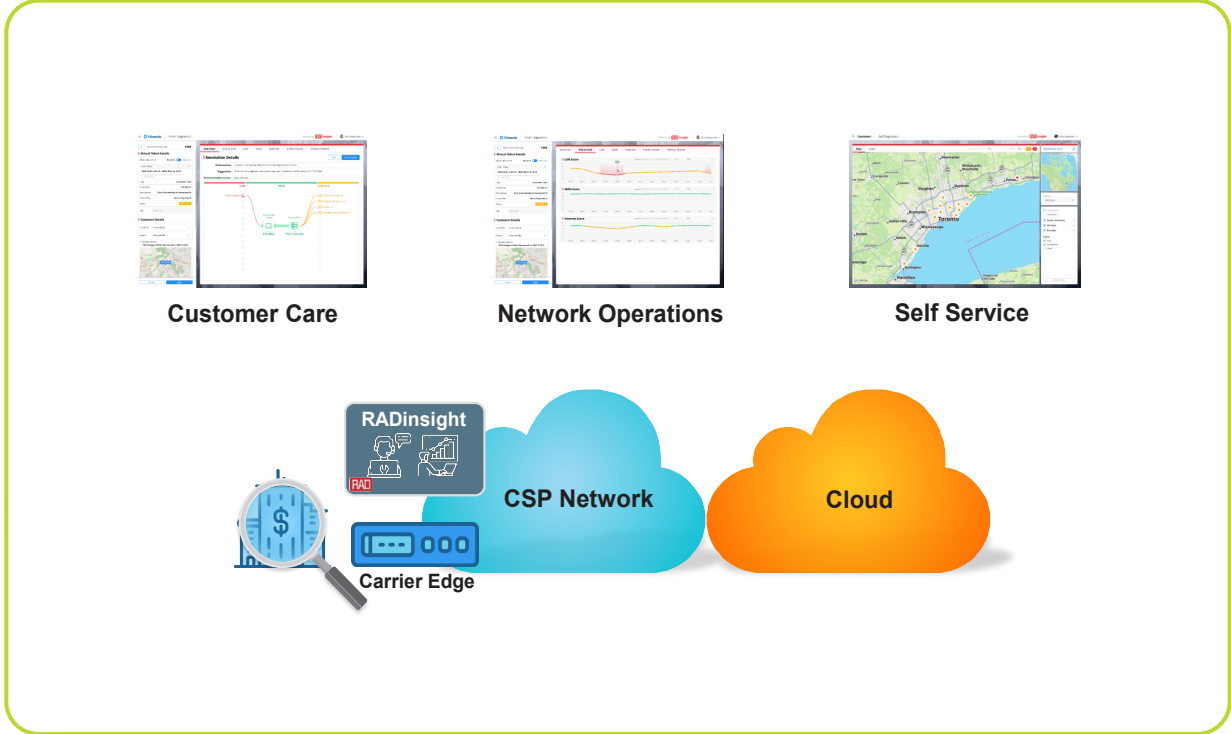

## Your Benefits:

- Root cause diagnostics and predictions as a service
- Complete network visibility from the customer LAN through the CSP network, to the cloud where applications reside
- Reduce service calls and improve first-call resolution
- Identify at-a-glance service connectivity issues affecting users, end-to-end
- Intuitive dashboard presents problem, cause and troubleshooting in plain language
- AI/ML-driven analytics
- Leverage the existing installed base of network edge equipment; no need for software agents
- Optional self-service portal for enterprise customers



**RADinsight SD**  
On-Demand Smart Diagnostics Service



**ETX-2/ETX-2i**  
1G/10G/100G Carrier Ethernet Demarcation



# DDoS Protection at the Edge

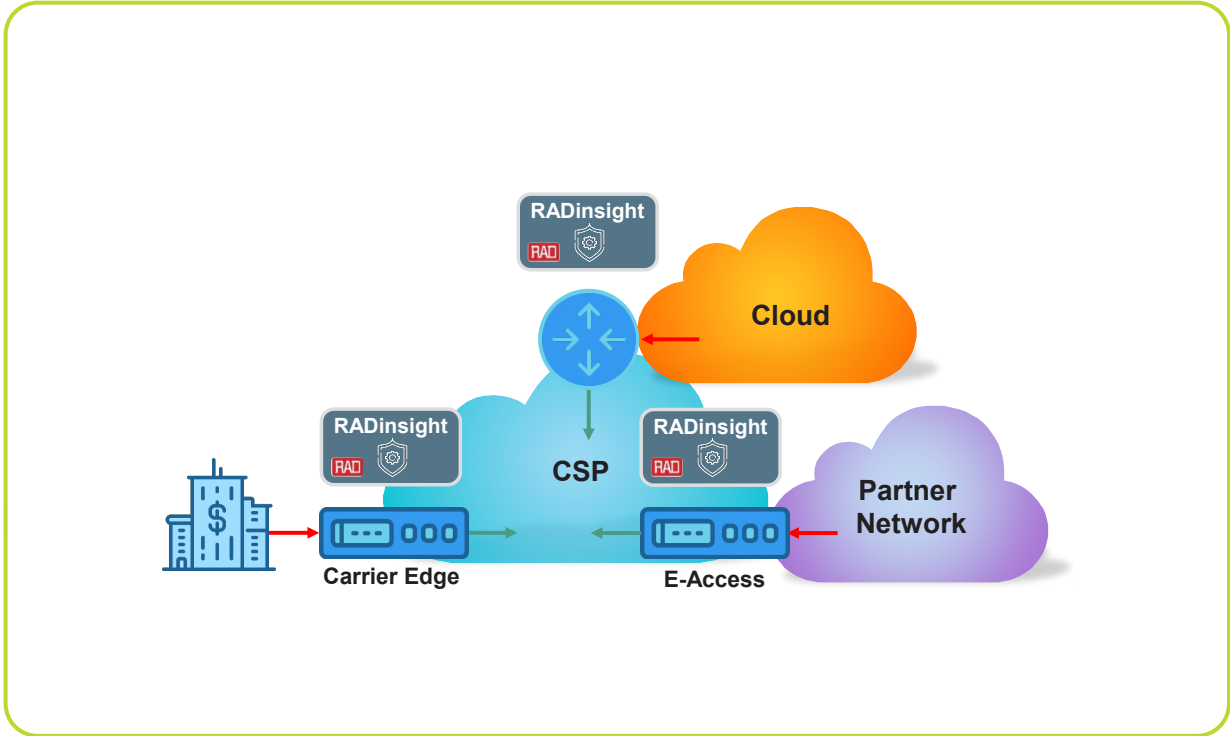

### Your Benefits:

- SaaS solution closes current security gaps
- DDoS protection embedded at the network edges: At the customer's, L2 interconnect and peering points
- Volumetric and low thresholds attack detection and characterization
- Mitigation within seconds at the attack location
- Protects from inbound and outbound attacks
- Software-based; doesn't require additional appliances
- Mitigation capacity scales with the network



**RADinsight TI**  
On-Demand Threat Intelligence Service



**ETX-2/ETX-2i**  
1G/10G/100G Carrier Ethernet Demarcation



# IP Traffic Encryption

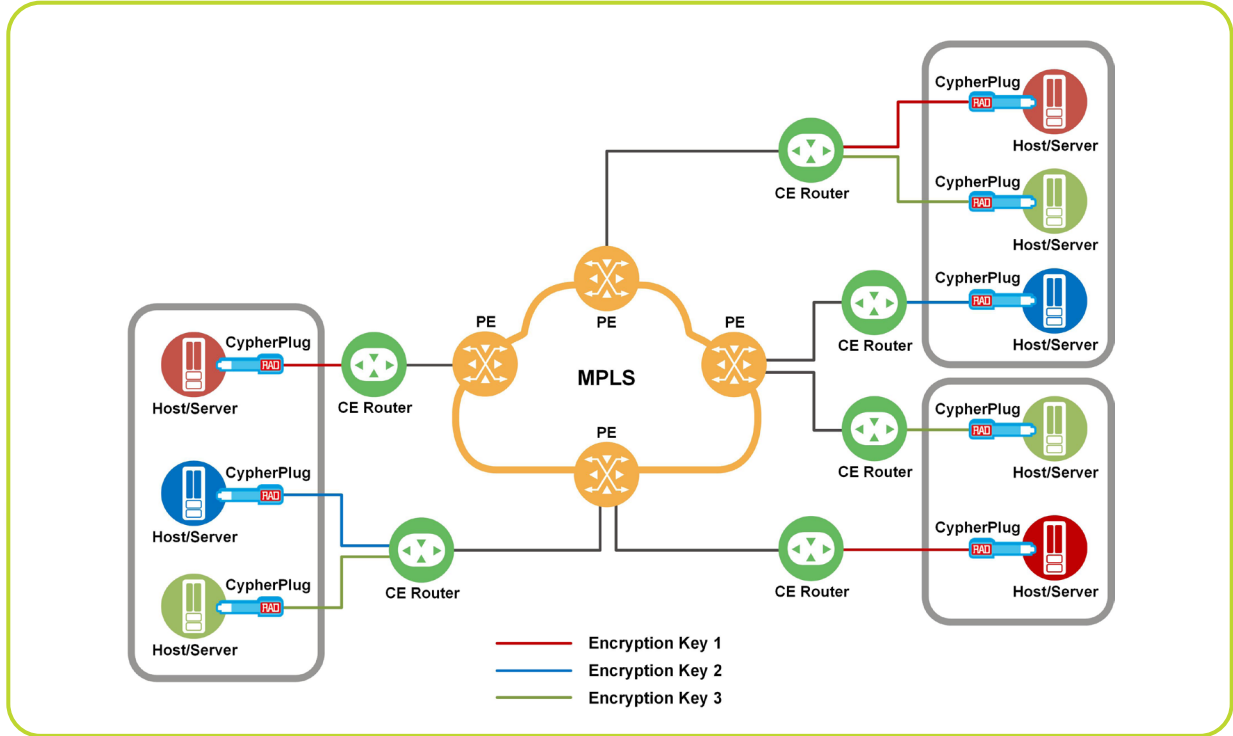

### Your Benefits:

- End-to-end static transport mode IPsec encryption
- Seamless security enhancement for existing deployments using an SFP sleeve
- Traffic encryption without changing network gear and structure
- Easy plug-and-play into standard MSA SFP ports of switches, routers, DSLAMs and mobile base stations
- Powerful FPGA design for wire-speed encryption
- Encryption key allocation allows service isolation between departments
- CypherPlug keeps the keys secret, without exposing them to field technicians
- Allows OpEx savings by eliminating the need for external power and reducing space and cabling expenses



**CypherPlug®**  
Miniature Network Security Device

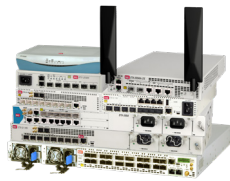

**Carrier Edge**  
Ethernet Demarcation Devices



**SecFlow**  
Ruggedized IIoT Gateways



**Megaplex**  
Next-Generation Multiservice Access Node



# Asset Monitoring with Edge Computing

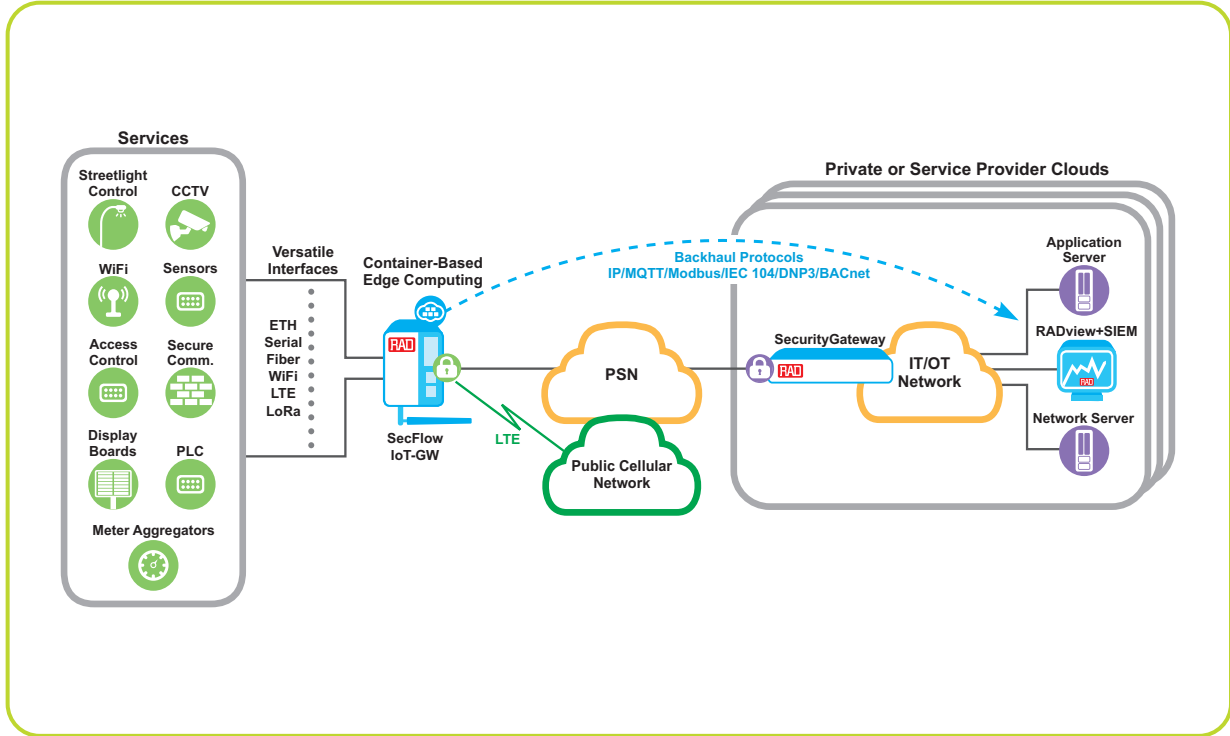

## Your Benefits:

- Offer competitive IoT services for monitoring and automation devices
- Edge Computing for user-tailored applications allows customers to add new applications on top of SecFlow devices
- Zero-touch provisioning, enhanced cyber security (IPsec, PKI, FW, IDS/IPS, SIEM)
- Seamless communications over fiber optics, radio links and 2G/3G/4G/5G cellular links
- Secure remote access for end-user device management
- LoRaWAN gateway functionality reduces the number of devices in the network
- Transparent delivery of SCADA, protocol conversion and terminal server
- Complies with IEC 61850-3 and IEEE 1613 environmental standards



**SecFlow**  
Industrial IoT Gateway  
with Edge Computing



**SecurityGateway**  
VPN Aggregator, Router  
and Firewall



**RADview**  
Management and Domain  
Orchestration



# IoT over Private 4G/5G Networks

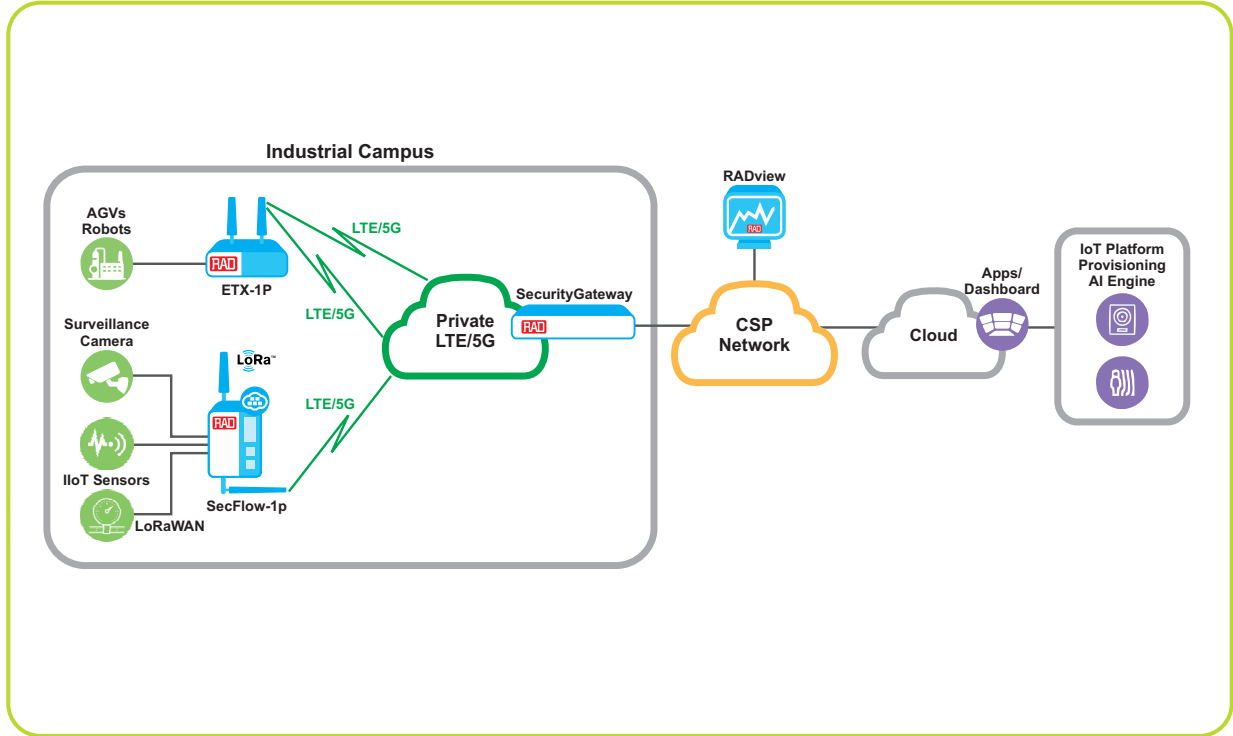

### Your Benefits:

- Deliver secure and reliable IoT connectivity services to enterprise campuses
- Ultra-resilient connectivity to the cloud over LTE and 5G networks
- Flexible connectivity for IIoT devices over LoRaWAN, WiFi Halow, serial, Ethernet links
- Scalability and reliability
- Edge Computing capabilities for IoT agents and cyber-security containers
- Enhanced security – IPsec, IDS/IPS, anomaly detection, stateful firewall
- Zero-touch provisioning
- Supports legacy SCADA and new generation IIoT sensors and devices
- Fits various verticals and use cases with special certifications
- Optional end-to-end solution including IIoT sensors and devices, gateway, IoT platform and dashboard



**ETX-1p**  
SMB IoT Gateway  
with Edge Computing



**SecFlow**  
Industrial IoT Gateway  
Programmable Logic Controller



**SecurityGateway**  
VPN Aggregator, Router  
and Firewall



**RADview**  
Management and Domain  
Orchestration



# IoT as a Service for SMBs

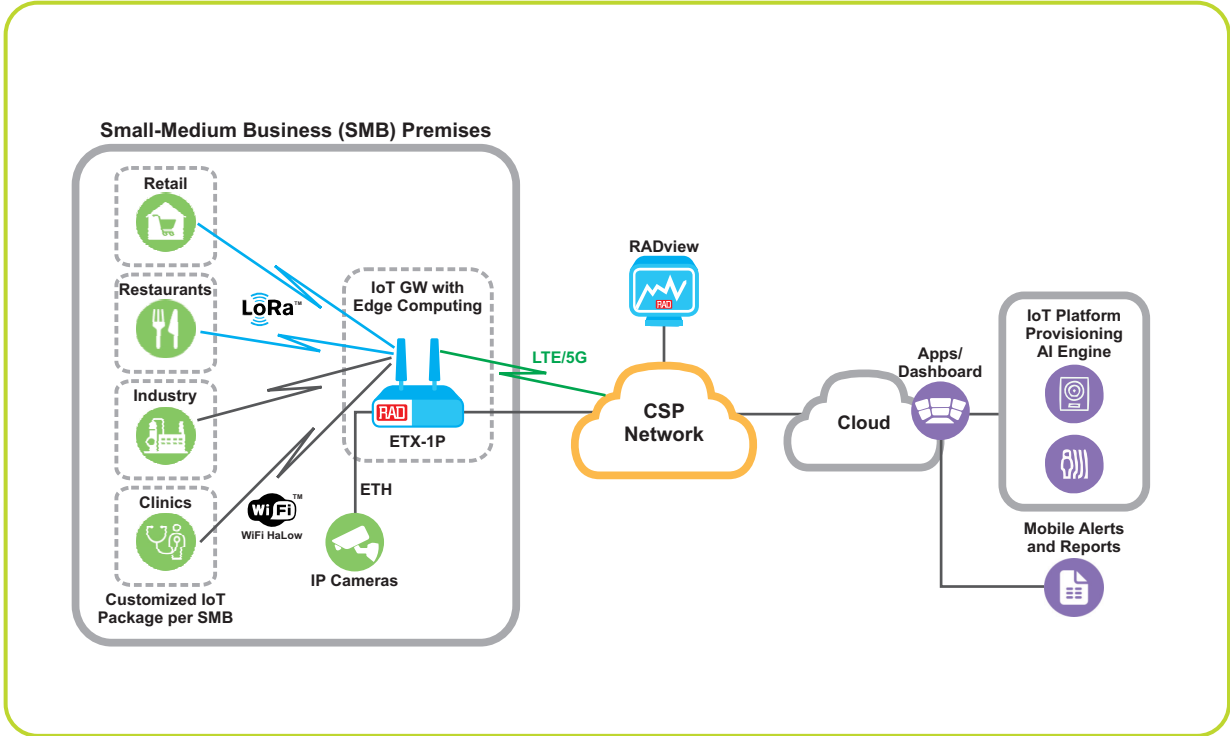

### Your Benefits:

- Enable IoT service packages for connected assets and environments using smart IoT devices
- Support customized offering for various SMB types with built-in applications
- End-to-end solution, from IoT devices and platforms, IoT gateway and IoT platform connectivity
- Secure connectivity from the business location to the cloud and IoT platform over fiber, 5G/LTE
- Edge Computing for enhanced cyber security and IoT functionalities
- Plug-and-play solution for easy installation; doesn't require dedicated IT teams



**ETX-1p**  
SMB IoT Gateway with Edge Computing



**SecFlow**  
Industrial IoT Gateway Programmable Logic Controller



**RADview**  
Management and Domain Orchestration



**IoT Platform**  
Data Collection, Processing, Visualization, and Device Management



# TDM Migration

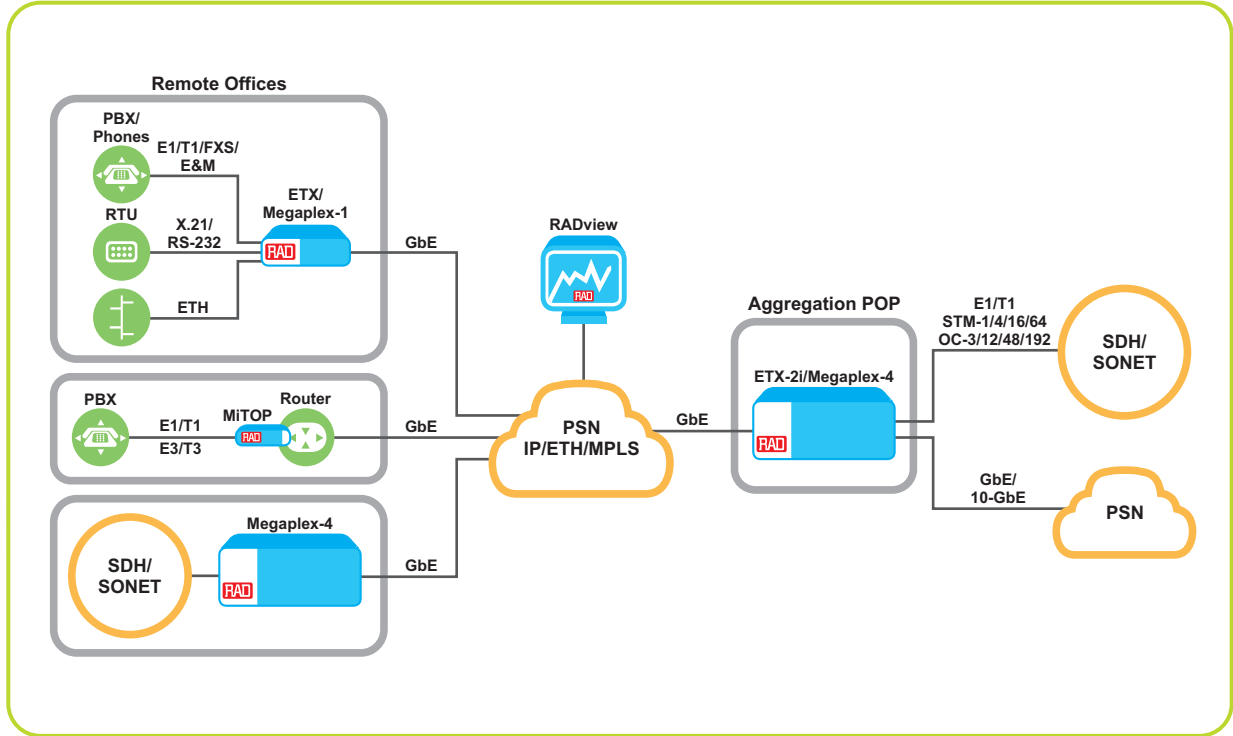

### Your Benefits:

- Maintain legacy TDM services over new packet network to keep revenue flow and customer loyalty
- Enable alternative providers to add leased lines to their service portfolio to attract new customers
- Allow fork-lift TDM (SDH/SONET) infrastructure replacement to PSN without affecting legacy (high revenue) customers
- Support heterogenic First Mile footprint requiring CPE support for DSL/EFM, Ethernet, GPON connections, and flexibility in PWE termination options: Customer site-to-customer site, customer site-to-POP/network, POP-to-POP
- Allow a single transport network for IP/Ethernet and TDM services to simplify operations and lower TCO



**ETX-2/ETX-2i**  
Carrier Ethernet Demarcation



**Megaplex-4**  
Next-Generation Multiservice Networking Node



**MiTOP-E1/T1, E3/T3**  
Smart SFP-Format TDM Pseudowire Gateways



**RADview**  
Management and Domain Orchestration



# 4G/5G Mobile xHaul

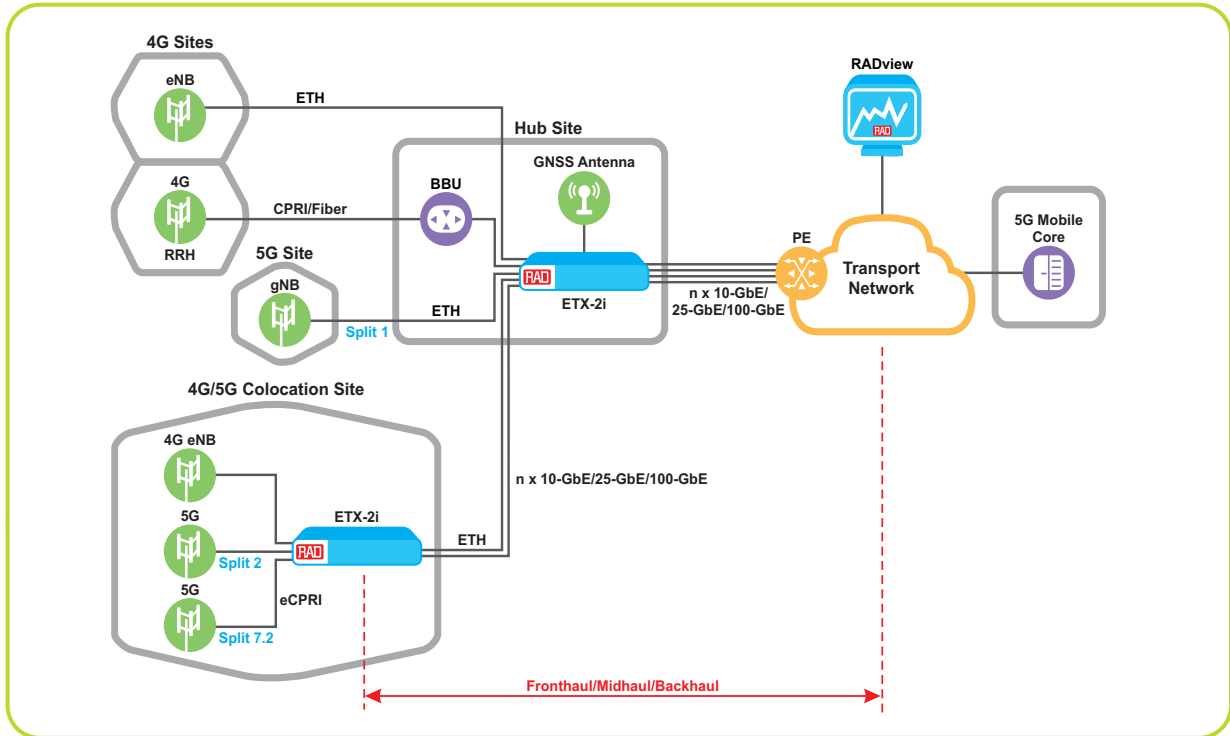

### Your Benefits:

- Fast rollouts of 5G deployments with in-field future upgrades to meet new requirements
- CSG for multiple 5G RAN/O-RAN splits and collocated 4G/5G sites
- Highly efficient 4G/5G aggregation: 10G, 25G and 100G
- Support wholesale and direct MNO applications
- Fixed-mobile convergence: Colocated mobile and fixed broadband sites
- Multi-CoS Carrier Ethernet/IP backhaul with service management and OAM-based diagnostics
- 1588 PTP (GM, BC Class B, TC) with integrated GNSS receiver, eSync-E for timing synchronization
- L2, L3-based fronthaul/midhaul/backhaul performance monitoring for multiple network slices and for network sharing
- Small form factor to meet space and power supply restrictions
- Ruggedized enclosure for outdoor installations

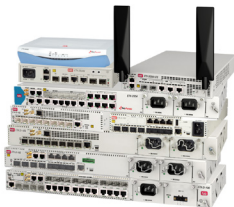

**ETX-2/ETX-2i**  
Carrier Ethernet Cell-Site Gateways up to 100G



**ETX-2i-10G Clamshell**  
Ruggedized Cell-Site Gateway



**ETX-2i-100G**  
100G Carrier Ethernet Demarcation



**RADview**  
Management and Domain Orchestration



# Timing Synchronization for Mobile Networks

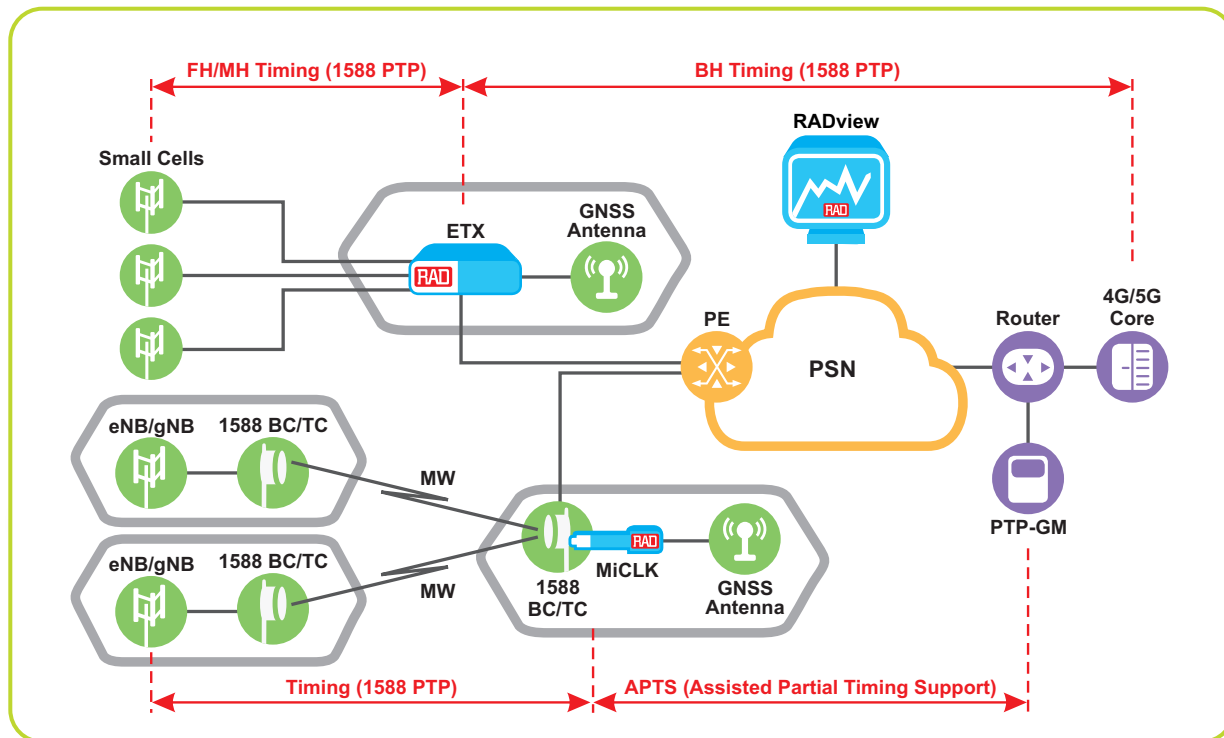

## Your Benefits:

- Addressing stringent timing requirements (frequency/phase) for LTE/LTE-A/5G macro and small cells with a fully featured PTP Grandmaster:
  - ETX-2 in a local POP/hub
  - MiCLK unique SFP plugged into an aggregation switch
- Enhanced cost efficiency by bringing PTP Grandmaster closer to the cell site
- Built-in GNSS receiver eliminates the need for a GNSS antenna on every cell site; avoids spoofing and jamming
- Full network coverage, even in underground and indoor installations
- Fits existing installed base – no need for CapEx investments in retrofitting network with 1588 BC/TC support across the entire path
- Robust GNSS (GPS/GLONASS) backup – time holdover for 72 hours, using Sync-E or 1588 frequency references from the network (Assisted Partial Timing Support)



**ETX-2/ETX-2i**  
Carrier Ethernet Demarcation



**MiCLK**  
1588 Grandmaster on an SFP



**RADview**  
Management and Domain Orchestration



# Critical Infrastructure

## Enabling Industrial Digitalization and Secure IoT

RAD solutions address all communication needs of utility, transportation, government, and oil and gas sectors with always-on reliability and mission-critical protection. We offer best-of-breed tools for cyber-secure asset monitoring, operational WAN, Edge Computing, Smart/Safe City, and critical infrastructure deployments. We also ensure seamless migration to packet switched communication networks and applications.

Key solutions include:

- Secure networking for digital transformation to allow for fast, secure and economical deployment of thousands of new remote asset monitoring sites
- Multiservice, packet and PoE-intensive operational technology (OT) WANs, supporting mission-critical data, voice and video applications
- Seamless communications over fiber, radio, 2G/3G/4G/5G cellular links, and leased lines
- Extensive security suite includes SCADA-aware firewall, intrusion prevention, man-in-the-middle attack prevention, encryption, device connection control, event logger, and anomaly detection
- Support a variety of wireless technologies for SCADA and Industrial IoT connectivity: CBRS, Anterix, 450 MHz, WiFi Halow, LoRaWAN, and LTE/4G and 5G
- Edge Computing allows flexible addition of software applications including protocol conversion, cyber security, IoT platform and video control and functionalities

# Smart Grid and Substation Automation

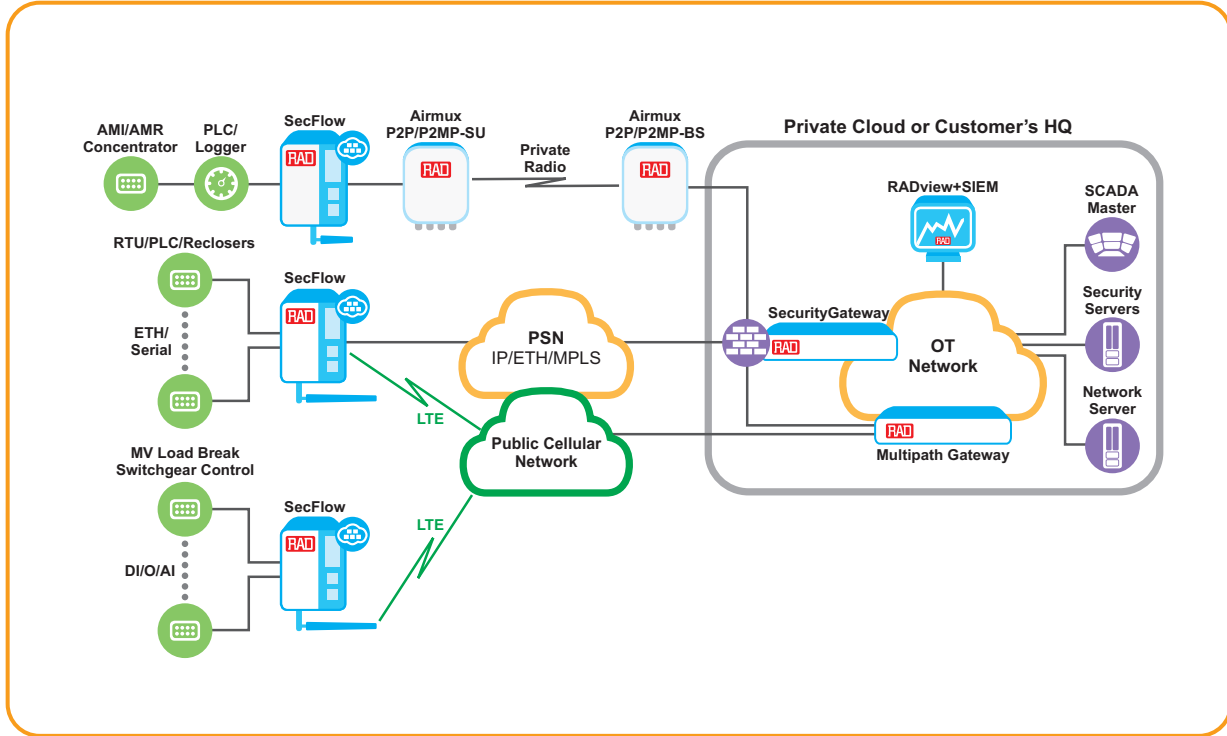

## Your Benefits:

- A comprehensive and secure solution addressing communications to secondary substations, metering and distribution automation
- Integrated IEC 61131-3 RTU/PLC
- Integrated LoRaWAN gateway
- Edge Computing for user-tailored applications allows customers to add new applications on top of SecFlow devices
- Zero-touch provisioning, enhanced cyber security (IPsec, PKI, FW, IDS/IPS, SIEM)
- Seamless communications over fiber optics, radio links, 2G/3G/4G/5G cellular links, and leased lines
- Multipath VPN to ensure resilient, secure and reliable connectivity
- Transparent delivery of SCADA, protocol conversion and terminal server
- Complies with IEC 61850-3 and IEEE 1613 environmental standards
- Point-to-multipoint radio connectivity supports high capacity mission-critical traffic over licensed and unlicensed sub-6 GHz bands



**Ceragon/Airmux**  
Wireless Transport Platform



**Multipath Gateway**  
Multipath Aggregator



**SecFlow**  
Industrial IoT Gateway with Programmable Logic Controller



**SecurityGateway**  
VPN Aggregator, Router and Firewall



**RADview**  
Management and Domain Orchestration

# Asset Monitoring for Power Transmission Towers

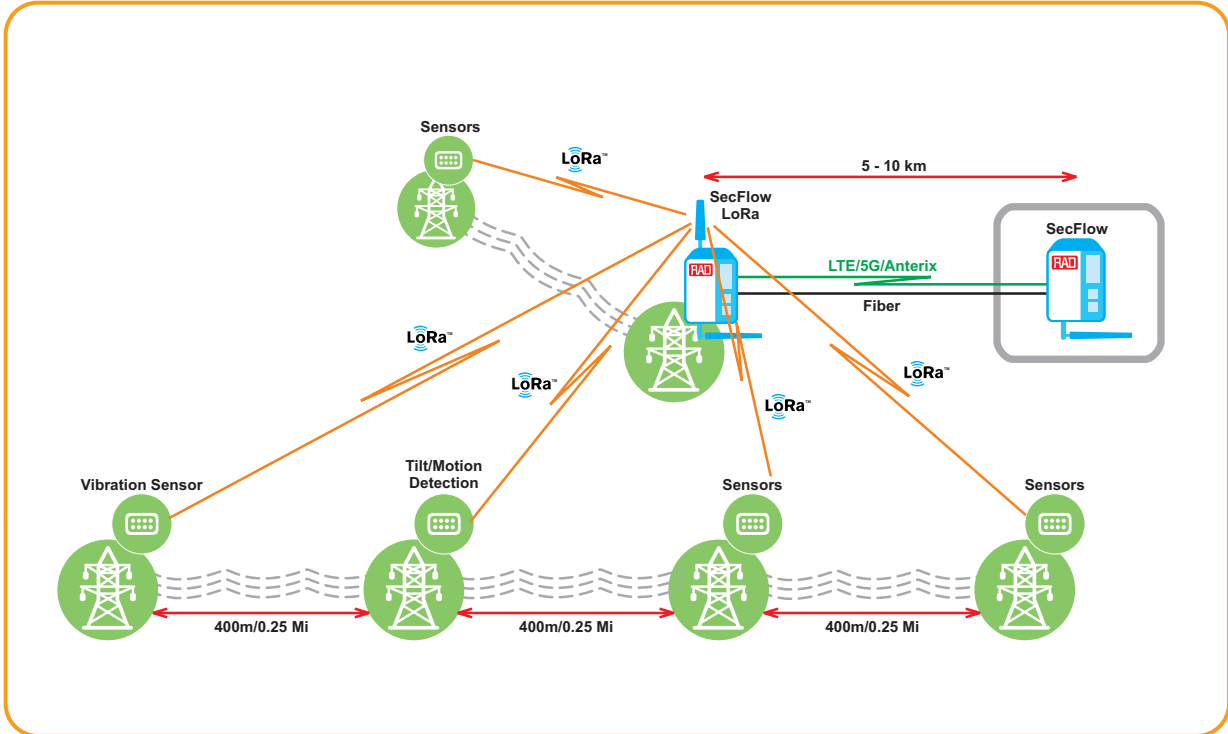

## Your Benefits:

- Secure solution for effective and economical asset monitoring
- Ruggedized IIoT gateway fits extreme conditions
- Super-low power consumption by design
- Docker-based Edge Computing, flexible software selection
- Compatibility with any IIoT platform, LoRa LNS or packet forwarder
- Unique LoRaWAN and WiFi Halow master and slave architecture for large area coverage
- eSIM support
- Real-time geo-location support
- Flexible wireline and wireless connectivity options
- Sensors and solar-powered batteries available



**SecFlow**  
Industrial IoT Gateway with Programmable Logic Controller



**RADview**  
Management and Domain Orchestration

# Power Utility Communications: Multiservice Operational WAN

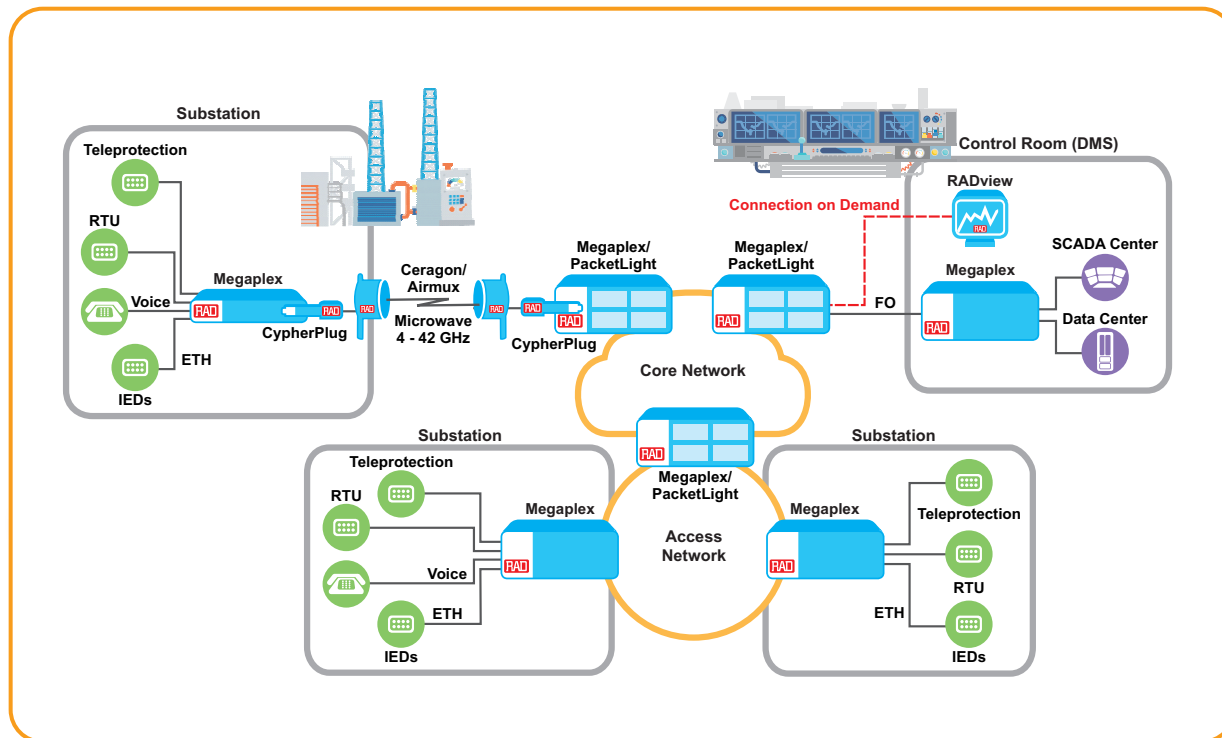

## Your Benefits:

- Powerful cross-generation TDM, MPLS and Ethernet capabilities, including TDM DSO cross connect and SDH/SONET, Carrier Ethernet with OAM and assured QoS, TDM pseudowire, and Ethernet over NGPDH/SDH/SONET
- Complete cyber suite, including encryption, authentication and authorization
- Easy connectivity of all services including Teleprotection over either SDH/SONET or a packet network
- Supports analog and digital data and voice devices, as well as Ethernet IEDs, with versatile rates from DSO (time slot) up to STM-64/OC-192 or 10-GbE
- Guaranteed smooth migration to PSNs based on hybrid design for reduced latency and better resiliency
- Point-to-point and point-to-multipoint radio connectivity supports high capacity mission-critical traffic over licensed and unlicensed bands
- CypherPlug encrypts traffic over any L2/L3 network



**Ceragon/Airmux**  
Wireless Transport Platform



**CypherPlug**  
Miniature IP-Level  
Network Security Device



**Megalex**  
Next-Generation Multiservice  
Networking Node



**PacketLight**  
Complete Solutions for WDM/OTN  
and Dark Fiber Applications



**RADview**  
Management and  
Domain Orchestration

# Oil & Gas Communications

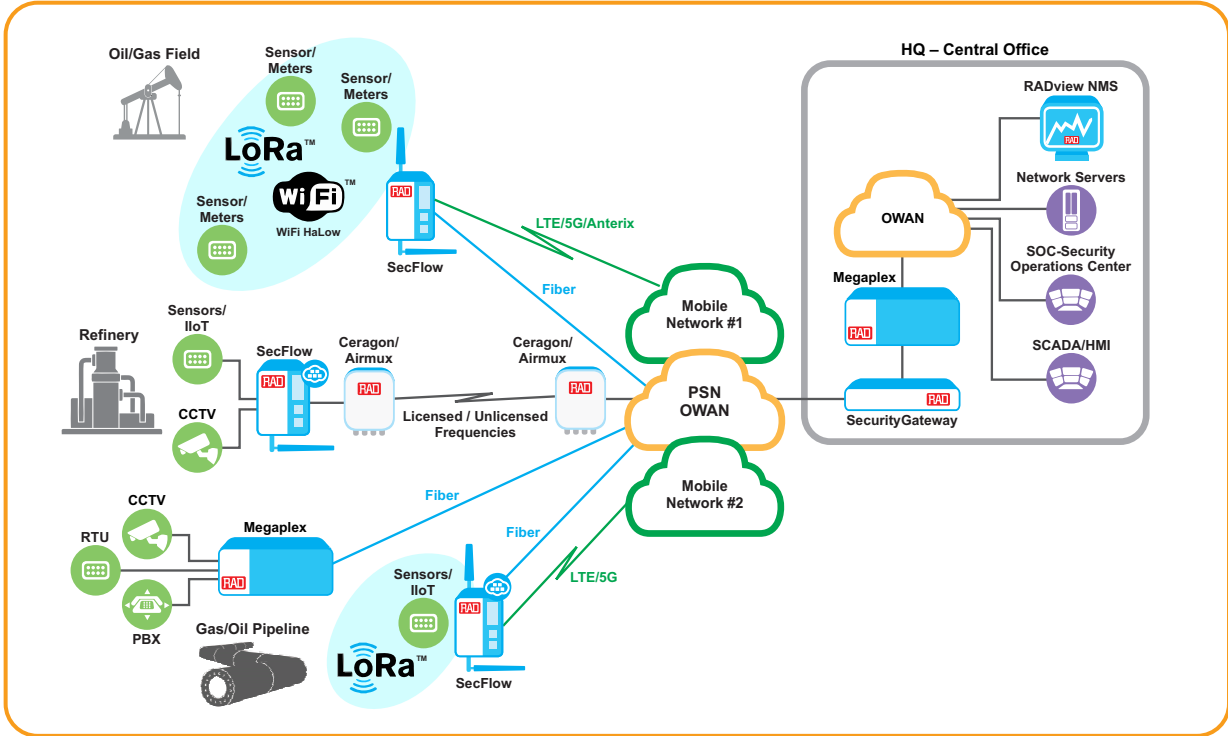

## Your Benefits:

- Seamless communications over fiber, radio, 3G/4G/5G, CBRS, Anterix, leased lines
- SCADA and IIoT backhaul, protocol conversion and integrated PLC/RTU
- Integrated LoRaWAN or WiFi Halow gateway
- Operational voice, video, data aggregation, and transport for legacy SCADA and new IIoT devices
- Ultra-resilient for uninterrupted operations
- Edge Computing processing and storage for a variety of added-value IIoT platform agents, cyber security, video processing, and automation
- PtP and PtMP radios over licensed and unlicensed bands
- Enhanced cyber security – IPsec, PKI, FW, IDS/IPS, SIEM/SOC
- Zero-touch provisioning for easy deployment
- End-to-end operational network management and monitoring
- Complies with HAZLOC and other utility certifications



**SecurityGateway**  
VPN Aggregator, Router and Firewall



**PowerFlow**  
Managed Ruggedized Ethernet Switch with Power over Ethernet



**Smart SFPs**  
G-PON and XGS-PON OLT in an SFP



**CypherPlug**  
Miniature IP-Level Network Security Device



**Megaplex**  
Next-Generation Multiservice Networking Node



**SecFlow**  
Industrial IIoT Gateway with Programmable Logic Controller



**Ceragon/Airmux**  
Wireless Transport Platform



**RADview**  
Management and Domain Orchestration



# Highway Communications

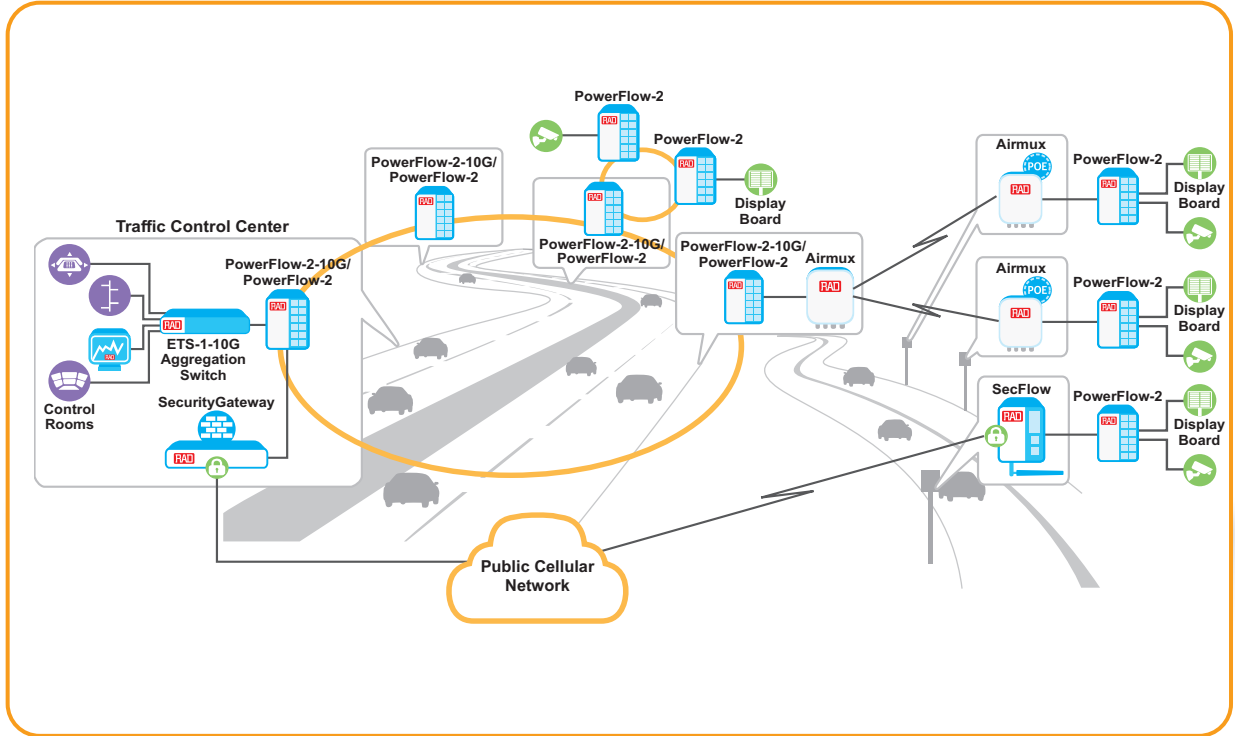

## Your Benefits:

- Backhaul high-definition video feeds, roadside display board and billing station data from remote facilities over fiber, high throughput microwave PtP and PtMP radio links, and 10-GbE rings
- Enable outdoor installations with industrial design and ruggedized enclosures
- Extensive PoE support including PoE++ and Airmux PoE
- L2 MPLS support
- 10-GbE carrier-grade Ethernet core rings with traffic management capabilities ensure reliable connectivity with appropriate quality of service for various applications
- 5G support where fiber isn't available



**SecFlow**  
Ruggedized SCADA-Aware  
Ethernet Switch/Router



**ETS-1**  
Ethernet Access Switches



**Ceragon/Airmux**  
Wireless Transport Platform



**PowerFlow**  
Managed Ruggedized Ethernet  
Switch with Power over Ethernet



**RADview**  
Management and Domain  
Orchestration



# Operational WAN for Trains and Metros

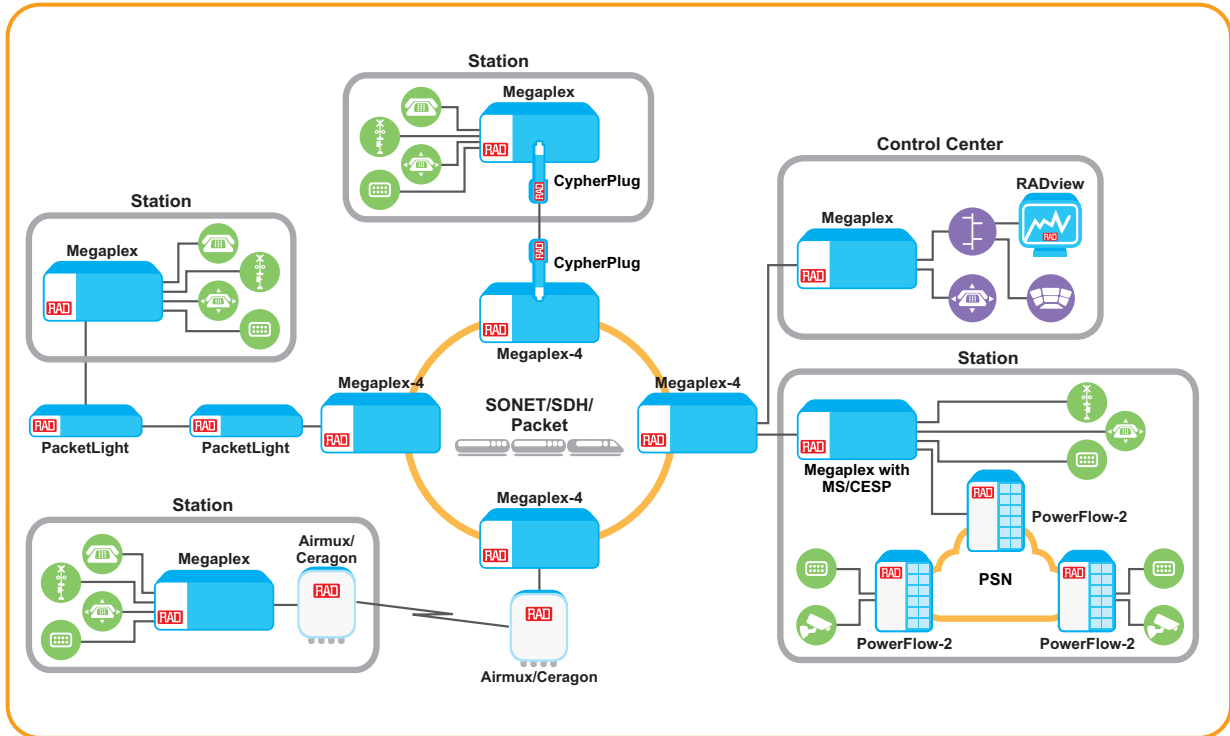

### Your Benefits:

- Ensure protected connectivity between stations and control room using multidrop and ring topologies
- Ethernet extension over fiber or copper (SHDSL) to enable service reach to remote M2M and video devices
- Support mission-critical railway applications, including automatic train supervision (ATS), centralized traffic control (CTC), SCADA, and multiparty hotlines, as well as passenger information systems (PISs)
- Support legacy TDM and Ethernet traffic delivery over SDH/SONET/IP/MPLS/MPLS-TP/CE/DWDM/OTN and/or carrier-grade fiber optic rings
- Support analog and digital data and voice devices, as well as Ethernet IEDs, with versatile rates from RS-232 up to STM-64/OC-192 or 10-GbE
- Point-to-point and point-to-multipoint radio connectivity supports high capacity mission-critical traffic over licensed and unlicensed bands
- CypherPlug encrypts traffic over any L2/L3 network



**Ceragon/Airmux**  
Wireless Transport Platform



**PacketLight**  
Complete Solutions for WDM/OTN and Dark Fiber Applications



**Megaplex**  
Next-Generation Multiservice Networking Node



**PowerFlow**  
Managed Ruggedized Ethernet Switch with Power over Ethernet



**CypherPlug**  
Miniature IP-Level Network Security Device



**RADview**  
Management and Domain Orchestration



## Multiservice Operational WAN for Air Traffic Control

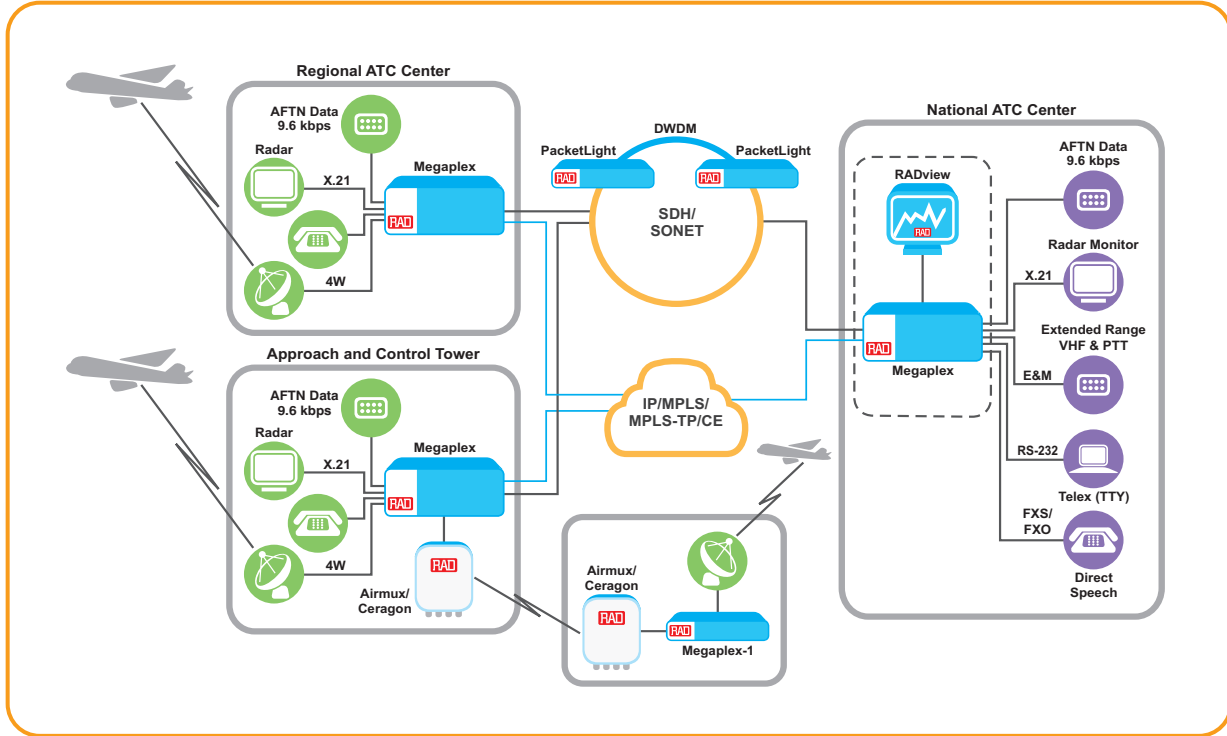

### Your Benefits:

- Ensure reliable, uninterrupted communications between different traffic control centers with RAD's multiservice connectivity solutions over any transport network, including SDH/SONET, IP/MPLS, MPLS-TP, CE, OTN, DWDM
- Deliver direct speech (DS), Telex (TTY), radar data (RD), extended range VHF (ER), and VHF data link (VDL) traffic, together with other voice, fax and LAN services, using industry-standard interfaces
- Transport traffic over copper, fiber, microwave, or satellite links
- Distributed SCADA security suite with integrated firewall and encryption
- Optimized for subrate leased line transmission and backup to reduce OpEx
- Ruggedized platforms withstand the rigors of field operations
- Support fail-safe operations with ISDN, VSAT and Ethernet backup



**Megaplex**  
Next-Generation  
Multiservice Networking  
Node



**PacketLight**  
Complete Solutions for WDM/OTN and  
Dark Fiber Applications



**Ceragon/Airmux**  
Wireless Transport  
Platform



**RADview**  
Management and  
Domain Orchestration

# Smart City Communications: Asset Monitoring and Operational WAN

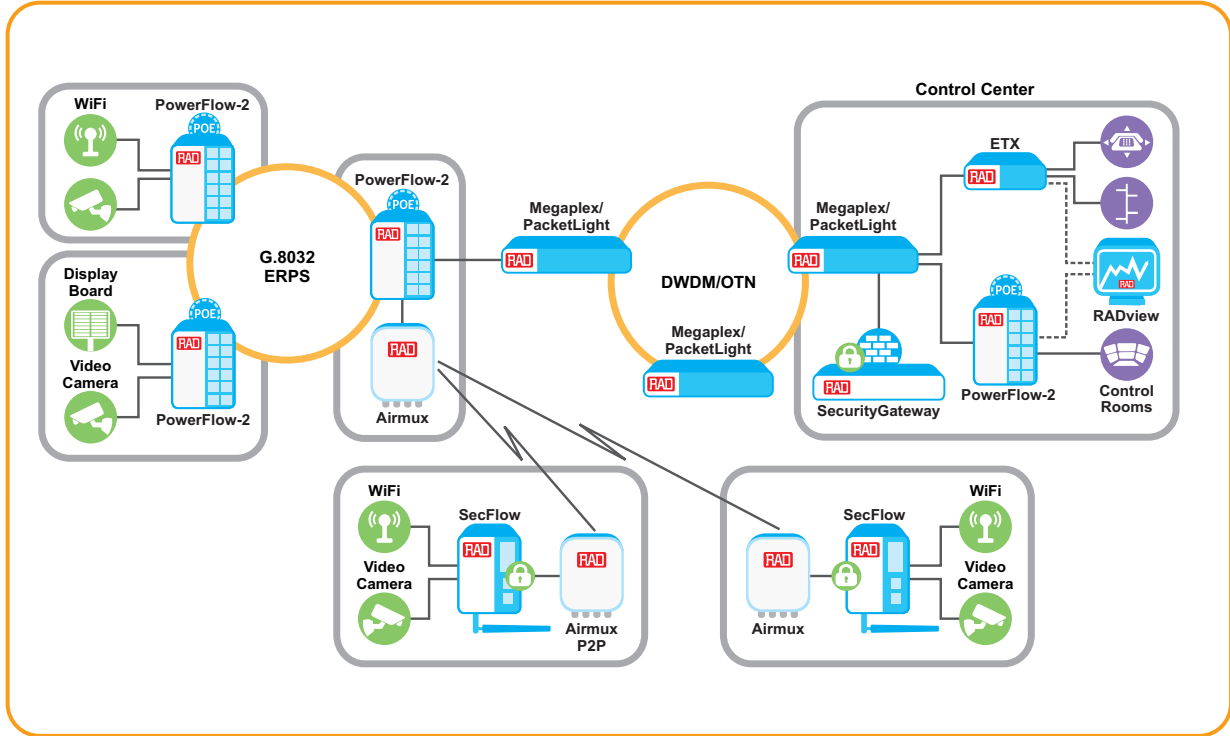

## Your Benefits:

- A comprehensive communication solution for ruggedized devices in outdoor installations, including CCTV cameras, WiFi access points, sensors, payment kiosks, etc.
- Allows customers to add new tailor-made applications on SecFlow devices using Edge Computing
- Establish a long-distance fiber optic private network backbone utilizing OTN/DWDM multi-tunneling technology, supporting data rates of up to 100G.
- Secure remote access for end-user device management
- Seamless communications over fiber, radio, 2G/3G/4G/5G cellular links, and leased lines
- Zero-touch provisioning with enhanced cyber security (integrated IPsec, encryption, stateful firewall, SIEM)
- Transparent delivery of legacy traffic from serial-based devices
- Point-to-multipoint radio connectivity supports high-capacity mission-critical traffic over licensed and unlicensed sub-6 GHz bands
- G.8032 Ethernet Ring Protection Switching (ERPS) and PoE support



**Ceragon/Airmux**  
Wireless Transport Platform



**SecFlow-1p, SecFlow-1v**  
Industrial IoT Gateways with Edge Computing



**Megaplex**  
Next-Generation Multiservice Networking Node



**PowerFlow**  
Managed Ruggedized Ethernet Switch with Power over Ethernet



**RADview**  
Management and Domain Orchestration



# First Responders and Military Communications

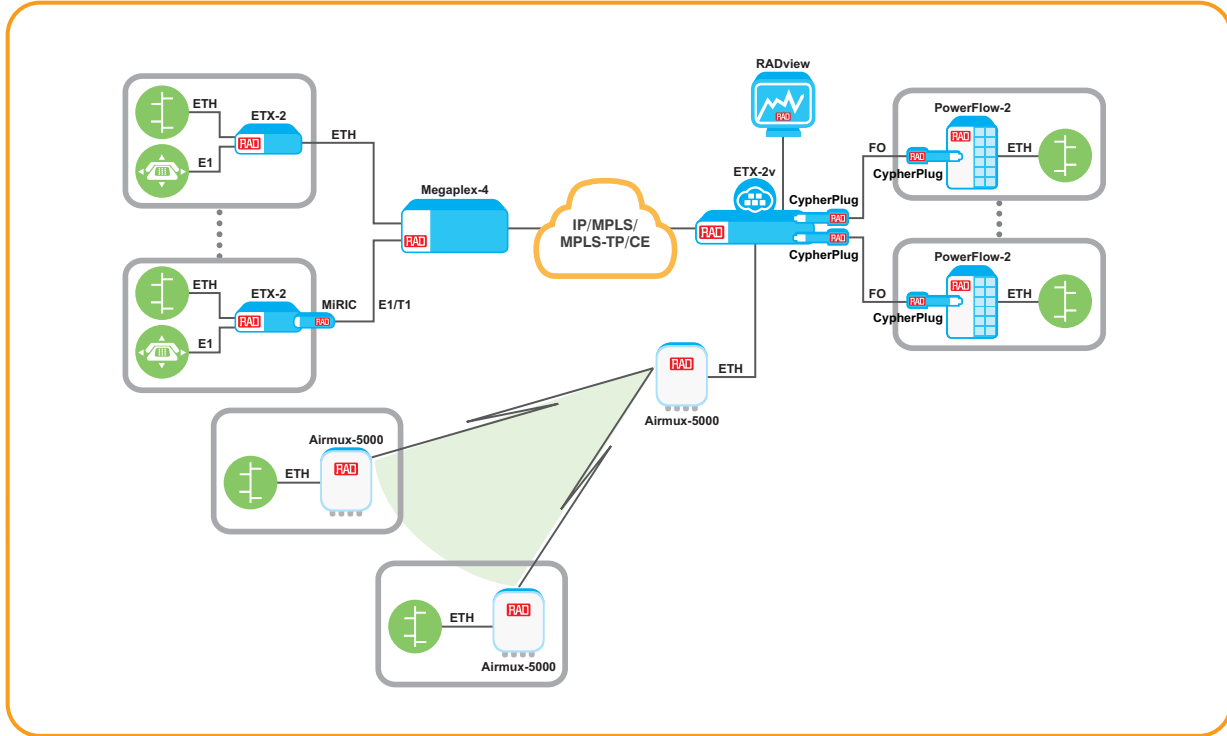

## Your Benefits:

- Connect a privately owned government/military/public network to remote sites using diverse infrastructure
- Support multiple services, including Ethernet, TDM and low speed data, using the same device
- Utilize existing SDH/SONET network or build a state-of-the-art IP/MPLS, MPLS-TP, CE backbone
- Secure remote access for end-user device management
- CypherPlug encrypts traffic over any L2/L3 network



**Airmux-5000**  
Point-to-Multipoint Broadband Wireless Access



**PowerFlow**  
Managed Ruggedized Ethernet Switch with Power over Ethernet



**CypherPlug**  
Miniature IP-Level Network Security Device



**ETX-2/ETX-2i**  
Carrier Ethernet Demarcation



**ETX-2/ETX-2i**  
Carrier Ethernet Demarcation - Outdoor Units



**RADview**  
Management and Domain Orchestration



# RAD Products

• A

**Airmux-400/  
Airmux-400E**  
Point-to-Point Broadband  
Wireless Access



RAD's Airmux-400 series of point-to-point broadband wireless radios seamlessly deliver both native Ethernet and TDM services over a single wireless link, operating within various sub-6 GHz frequencies. With high capacity, the Airmux-400 radio systems boast an impressive aggregated throughput of up to 2.5 Gbps (Airmux-400E) and a remarkable range of up to 120 km (75 miles). These radio systems incorporate advanced features, including MIMO and OFDM, ensuring optimal performance and unmatched robustness in diverse environments. The Airmux-400 is exceptionally well-suited for several applications, including:

- Utilities Advanced Metering Infrastructure (AMI) or Distribution Automation (DA) backhaul
- Public safety and government backhaul
- Transportation (highways and railways backhaul)

- **Multi-band operations over 4.9 to 6.06 GHz in a single device**
- **20 MHz, 40 MHz, 80 MHz or 160 MHz channel bandwidth**
- **TDM over packet integration for TDM service support with other RAD TDMoIP products**
- **Net throughput (aggregated):**
  - Airmux-400H: up to 750 Mbps
  - Airmux-400A: up to 500 Mbps
  - Airmux-400E: up to 2.5 Gbps
- **OFDM, MIMO and antenna diversity capabilities**
- **Extended range – up to 120 km (75 miles)**
- **Hub-site synchronization (HSS) supports simultaneous transmission from up to 16 colocated Airmux-400 and/or Airmux-5000 units**
- **Ring protection link (RPL) for Ethernet resiliency**
- **Spectral power measurement and RF survey tool – “Spectrum View” – for quick and easy installation**
- **AES256 over-the-air encryption**

**Airmux-5000i/  
Airmux-5000D**  
Point-to-Multipoint Broadband  
Wireless Access



RAD's Airmux-5000 point-to-multipoint broadband wireless radios are the ideal wireless solution for business users demanding high capacity throughput with dedicated traffic bandwidth allocation and service level agreement (SLA) per subscriber. Featuring up to 750 Mbps aggregated sector capacity and a range of up to 40 km (25 miles), a single Airmux-5000i base station supports up to 64 remote subscriber units (SUs) with multi-band operation, making it ideal for:

- Service providers and ISPs, offering IP backhaul and 4G/broadband access for remote, rural and underserved communities
- Private networks requiring high capacity inter-branch connectivity for university campuses, healthcare organizations, government institutions, large enterprises, and public establishments
- Security and surveillance applications requiring aggregation and backhaul of traffic from multiple colocated HD cameras

- **Airmux-5000/5000i/5000D multi-band operations over 2.4 GHz, 3.3 – 3.8 GHz and 4.9 – 6.4 GHz in a single device**
- **Airmux-5000D includes two radios (3.x GHz and 5.x GHz) in a single unit**
- **Up to 750 Mbps aggregated throughput per sector/band**
- **Up to 64 remote subscriber units per sector with aggregated throughput of 5, 10, 20, 25, 50, and 100 Mbps**
- **Supports fixed and nomadic applications**
- **Airmux-5000i with beamforming antenna**
- **5 MHz, 10 MHz, 20 MHz, or 40 MHz channel bandwidth**
- **OFDM, MIMO and antenna diversity capabilities**
- **Range up to 40 km (25 miles)**
- **Intra- and inter-site TDD synchronization using hub-site synchronization (HSS) and GPS**
- **Low constant latency – typically 4 to 10 msec in full sector load**

- A
- B
- C
- D
- E
- F
- G
- H
- I
- J
- K
- L
- M
- N
- O
- P
- Q
- R
- S
- T
- U
- V
- W
- X
- Y
- Z

### BiDi QSFP Adaptor 100G/200G Dual to Single Fiber Adaptor

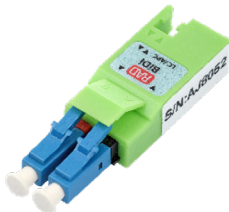

RAD's patented BiDi miniature passive adaptor fits any transceiver with LC connectors to perform simple dual to single bi-directional fiber connectivity. This 100G/200G QSFP adaptor doubles fiber capacity while avoiding costly new fiber/transceiver deployments. A simple to deploy bookend solution, it is ideal for network service providers, cloud providers, data center operators, and enterprise network operators wishing to better utilize their existing fiber. BiDi QSFP Adaptor allows them to simply pair a small form-factor passive adaptor with any fiber QSFP transceiver. This reduces the need for costly fiber trenching and frees up fiber for other services.

- 50% fiber savings with quick ROI
- Works at any bit rate: 40G, 100G, 200G
- Unique patented technology complements SFP+, QSFP28, QSFP-DD, QSFP+, CFP-2
- Compact and simple to deploy (no need for configuration or additional power source)
- Low insertion loss (<2 db including connectors)
- 1310-nm (1291-1312) wavelength at any supported bandwidth rate
- 1550-nm (1528-1567) wavelength at any supported bandwidth rate
- Operates over various optical distances: 10 km (6.2 miles), 20 km (12.4 miles), and 40 km (25 miles)
- Double fiber capacity while avoiding costly new fiber/transceiver deployments

### Ceragon FibeAir IP-20 Wireless Transport Platform



Ceragon's wireless transport platform accommodates various needs in different scenarios while maintaining availability and security at the highest standards.

The FibeAir IP-20 platform meets any critical infrastructure wireless transport need, of any scale, in any topology and at any frequency, combined with an advanced security feature set and low-latency performance.

The FibeAir IP-20 comes in all-outdoor, split-mount and all-indoor configurations supporting 6.86 GHz frequency range.

#### FibeAir IP-20C:

- Double wireless backhaul capacity via remote activation of another radio carrier with no site visits required
- Provides the highest radio capacity and spectral efficiency in any condition and any frequency channel size (up to 80/112 MHz)
- Field-proven 4x4 LoS MIMO technology - enabling 1-Gbps radio capacity over a single 30-MHz channel or 2 Gbps over a single 60 MHz

#### FibeAir IP-20E:

- Provides ultra-high radio capacity and spectral efficiency of up to 2.5 Gbps over a 500-MHz channel
- Minimizes your sites' physical footprint with an integrated flat panel antenna

#### FibeAir IP-20S:

- Compact, all-outdoor wireless backhaul node that is optimized for simple installation and operation
- Operates within the entire microwave spectrum (6 - 42 GHz)

A

B •

C •

D

E

F

G

H

I

J

K

L

M

N

O

P

Q

R

S

T

U

V

W

X

Y

Z



**Ceragon IP-50**  
Disaggregated Wireless  
Transport Platform



Ceragon's IP-50 series resolves modern wireless transport challenges via disaggregation that is implemented in three independent innovation paths: Radio, networking hardware and networking software.

- **IP-50E: 20 Gbps/link universal E-Band radio**
  - Radio capacity: 20 Gbps (2+0 XPIC configuration, utilizing two units)
  - Simple upgrade - utilize existing link in conjunction with the IP-50E with Layer 1 carrier bonding
- **IP-50C: Universal quad-carrier microwave solution - up to 8 Gbps**
  - Save tower load and shelter space with 4+0 configuration in all-outdoor deployments
  - The capacity you need, in any range, with 224-MHz channel support - up to 8 Gbps
  - 4x4 LoS MIMO
  - Advanced frequency reuse
  - Advanced space diversity
- **IP-50S: Universal microwave radio**
  - Simple upgrade - utilize existing link in conjunction with the IP-50S with Layer 1 carrier bonding
- **IP-50FX: Disaggregated wireless hauling router**
  - White box, merchant-silicon based hardware, with Ceragon Radio Aware Open Networking software for zero-compromise open-platform migration

**CESP VM**  
Virtual TDM Engine



This data/voice virtual machine processing engine can be installed on any X.86 or ARM platform. Working on any white box, the CESP VM provides seamless on-site or remote configuration in real time, replaces legacy and/or non-functioning voice compression products, and supports parallel processing on multi-core processors.

It is recommended for integration with ETX-2v, ETX-1p, SecFlow-1p, and its PWE engine is compatible with MiTOP, Megaplex-4 and ETX-205A.

- **Point-to-multipoint data/voice services**
- **Data encapsulation protocols V.110, R111, oversampling**
- **Terminal server functionality for serial data transport over IP/TCP/UDP, SSH**
- **Voice conversion (PCM, ADPCM, G729A, RTP)**
- **Service level protection**
- **Gateway from TDM to IP for both data (UDP/TCP) and voice (RTP)**
- **Highly efficient multi-core processes and algorithms**
- **Powerful PW and DS0 Interworking**

## CypherPlug® Miniature Network Security Device



CypherPlug® is a miniature IP-level network security device that encrypts traffic over any IP network. Its innovative design – an easy plug-and-play solution – breaks through the barriers of cost and complexity for customers seeking a high level of security for their networks.

It is an SFP sleeve form factor, capable of hosting any standard MSA-compatible 100-Mbps or 1-GbE SFP. CypherPlug transparently envelops a large variety of SFPs, enabling full reuse of customer equipment and seamless deployment over multiple access infrastructure types, such as short-haul and long-haul fiber connections, bidirectional single-fiber links, and copper lines.

The SFP sleeve is easily pluggable into standard MSA-compatible SFP ports of switches, routers, DSLAMs and mobile base stations, eliminating the use of external power and reducing space and cabling expenses.

The CypherPlug functionality is based on a powerful FPGA that enables easy customization to additional or different customer requirements.

- **End-to-end static transport mode IPsec encryption**
- **Designed for seamless protection enhancement of any existing SFP-based network device**
- **Wire-speed encryption (1000 Mbps)**
- **Low OpEx due to decreased power consumption, space and installation costs compared to other solutions**

## ETS-1 Ethernet Access Switches



The ETS-1 switches are high-performance devices suitable for various roles, serving as network edge, aggregation, or transport switches in carrier networks. Additionally, they function effectively as top-of-rack (ToR) or end-of-row switches in data centers.

The ports of these switches support operation at different rates, including 1 Gbps (SFP), 10 Gbps (SFP+), 40 Gbps (QSFP+), and 100 Gbps (QSFP28).

The non-blocking architecture ensures lossless packet forwarding at wire speed, with minimal and predictable delays for all types of traffic.

The switches' port configurations range from 10 x 1-Gbps up to 48 x 1-Gbps/10-Gbps, complemented by six 40-Gbps/100-Gbps uplink ports.

- **Stacking support**
- **Multicast support: IGMP snooping, MVR**
- **Advanced security: Multilayer ACLs, IP Source Guard, and Dynamic ARP Inspection**
- **High port density, up to 48 10G ports**
- **PoE/PoE+ support**
- **Ethernet OAM, QoS and rate limiting**

A

B

C •

D

E •

F

G

H

I

J

K

L

M

N

O

P

Q

R

S

T

U

V

W

X

Y

Z



• E

**ETX-1p**  
CPE for Branch Routing  
and Edge Access to Cloud

Hot Product



ETX-1p is an economical thin CPE enabling business customers' transition to the cloud. As a disaggregated CPE, it hosts virtualized function containers. By combining powerful networking capabilities with flexible connectivity options, rich management interfaces and embedded security functions, the ETX-1p enables service providers to deliver advanced IP-VPN services, as well as value-added virtual services from the data center to the customer branch. The all-in-one device includes an embedded router and a next-generation firewall, together with switching capabilities and LTE and WiFi support, making it easy to connect branches to private and public clouds over mobile or fixed broadband or over MPLS, without the need for extra hardware or complicated configurations.

ETX-1p is bundled with pCPE-OS, RAD's carrier-grade, Linux-based operating system. Designed to run on various ARM- and x86-based CPE platforms, it is security hardened and optimized to provide maximum performance at a low footprint.

- **Hosting of third-party software using Docker container technology**
- **Multiservice support: GbE copper and fiber**
- **Single or dual cellular modem for a 2G/3G/HSPA+/HSDPA/LTE uplink; dual SIM for always-on connectivity**
- **WiFi access point**
- **Dynamic routing with OSPF, BGP, VRF and secure VPN using IPsec, DMVPN and NAT for flexible connectivity**
- **Cyber security suite: 802.1X, IPsec encryption with automated PKI, stateful firewall**
- **Zero-touch provisioning, firewall configuration, fault management and reporting, bulk software upgrade, and database management using RADview**

**ETX-2**  
Carrier Ethernet Demarcation

The ETX-2 line of Carrier Ethernet NID/NTUs offers demarcation for SLA-based business services, wholesale services and mobile backhaul. The ETX-2 is MEF Carrier Ethernet 2.0-certified for E-Line, E-LAN, E-Tree, and E-Access services, as well as delivering TDM pseudowire over packet networks. Supporting high capacity service provisioning per EVC/EVC.CoS, flexible classification and H-QoS traffic management, it also performs accurate and scalable service testing and performance monitoring. The ETX-2 is supported by RADview management and enables a variety of protection mechanisms. It also offers NEBS-compliant and environmentally hardened enclosure options.



- A
- B
- C
- D
- E
- F
- G
- H
- I
- J
- K
- L
- M
- N
- O
- P
- Q
- R
- S
- T
- U
- V
- W
- X
- Y
- Z



- **ETX-203AX: Carrier Ethernet Demarcation Device**



ETX-203AX is ideal for carriers, service providers, and wholesale operators requiring advanced Ethernet functionality at customer premises and multi-tenant units (MTUs).

- Four and six FE/GbE ports; varied selection of SFP and copper interfaces
- Outdoor enclosure option
- Wide-range AC/DC power supply interfaces

- **ETX-203AX-T: Carrier Ethernet Device with LTE/Broadband Connectivity**



ETX-203AX-T extends Ethernet VPN services to new, out-of-reach locations, allowing rapid site commissioning by using readily available LTE or broadband networks. The ETX-203AX-T enables cost-effective Ethernet VPN services backup using LTE or broadband. Additional cost optimization can be achieved by splitting traffic between a service-assured VPN and best-effort LTE or broadband access.

- Five FE/GbE ports with varied selection of SFP and copper interfaces
- Optional built-in LTE modem with global service coverage
- Secure EVC tunneling over private IP/LTE networks or over the internet using L2oGRE or L2TPv3 protocols
- Full suite of MEF CE 2.0/MEF 3.0 standard capabilities for SLA monitoring, diagnostics and fault detection
- Data and management protection using LTE or broadband
- Integrated wide-range AC/DC power supply
- Fragmentation and IPsec support

- **ETX-205A Carrier Ethernet/Mobile Demarcation Device**



The ETX-205A provides advanced Carrier Ethernet demarcation and offers combo interfaces and power supply redundancy. For LTE/LTE-A mobile backhaul, the ETX-205A is installed at cellular tower and controller sites to guarantee differentiated SLAs.

- L2 VPN service demarcation with superior traffic management and monitoring capabilities
- Flexible synchronization offering Sync-E, IEEE 1588v2 slave, BC and TC for frequency and phase synchronization in mobile networks
- Distributed Grandmaster architecture integrating built-in GPS receiver with IEEE 1588v2 Grandmaster functionality for cost-optimized LTE deployments
- E1/T1 pseudowire services per MEF-8, UDP/IP, MPLS static labeling in SAToP and CESoP modes, and with CAS

A

B

C

D

E •

F

G

H

I

J

K

L

M

N

O

P

Q

R

S

T

U

V

W

X

Y

Z

• E

**ETX-2i**  
Carrier Ethernet  
Demarcation up to 100G

Hot Product

The ETX-2i line of next-generation NID/NTUs offers advanced demarcation for SLA-based, L2 business services, wholesale services and mobile backhaul with optional PTP- and/or GNSS-based timing. The ETX-2i offers a complete service life-cycle toolset, as per MEF 3.0 specifications.

The ETX-2i-100G offers a variety of Ethernet network products supporting 1-GbE, 10-GbE, 25-GbE and 100-GbE connections.

• **ETX-2i: Ethernet 1G Demarcation Device and Cell-Site Gateway**



Available as a modular demarcation device, the ETX-2i enables operators to deliver the most advanced Carrier Ethernet services over any network connection. In addition, the ETX-2i combines advanced timing functionalities for wholesale mobile xHaul.

- Up to eight GbE combo ports
- Integrated wire-speed switch/router
- Modular network interfaces: FE/GbE (combo), E1/T1, T3, VDSL2, or SHDSL
- Flexible synchronization offering Sync-E, IEEE 1588v2 slave, BC and TC for frequency and phase synchronization in mobile networks
- Supports O-RAN deployments
- NEBS-compliant and environmentally hardened enclosure options
- 3U device with six GbE combo ports and 64 x E1/T1, offering high scale, cost-effective TDM over packet services

• **ETX-2i-B: Ethernet Demarcation Device for SMBs**

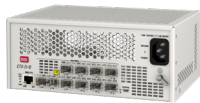

ETX-2i-B is a demarcation device optimized for remote branches and SMBs over native Ethernet access. It is ideal for carriers, service providers, and wholesale operators requiring advanced Ethernet L2/L3 functionality at customer premises and multi-tenant units (MTUs).

- 1U device with up to ten GbE ports
- Integrated 6-Gbps switch/router
- Fan-less 2U device with ten GbE ports, ideal for cost-effective small-cell aggregation
- Supports O-RAN deployments





• **ETX-2i-10G: 10G Carrier Ethernet Demarcation/Aggregation Device**

Hot Product

The ETX-2i-10G combines intelligent, high bandwidth demarcation and aggregation capabilities for enterprise headquarters and mobile backhaul operators. As an aggregation solution at the concentration point, a single unit can support numerous services and concurrent OAM sessions.



- 19" unit with up to eight 10-GbE and up to 24 GbE ports in various combinations
- Half unit with up to eight 10-GbE ports and up to eight GbE ports in various combinations
- Advanced timing with eSync-E and 1588v2 slave, BC (Class C) and TC for phase and frequency synchronization for video and mobile applications
- ITU-T G.8032 Ethernet Ring Protection Switching
- NEBS-compliant, outdoor and environmentally hardened enclosure options
- Supports O-RAN deployments



• **ETX-2i-100G: 100-GbE Carrier Ethernet Demarcation Device**

Hot Product

ETX-2i-100G delivers the full suite of Carrier Ethernet demarcation and aggregation capabilities, at 100-GbE rates. MEF 3.0-certified, the ETX-2i-100G addresses the increasing demand for high bandwidth access to data centers, while maintaining SLA guarantees, service monitoring, flexibility, and management.



- 19", 1U device with dual redundant power supply
- Four 100-GbE (QSFP28) and 16 x 1/10-GbE SFP+ interfaces
- Advanced QoS with hierarchical policing and bandwidth shaping per EVC and EVC.CoS
- Supporting 1G (SFP), 10G (SFP+), 25G (SFP28), 40G (QSFP+) and 100G (QDFP28) interfaces
- Accurate and scalable hardware-based OAM and performance monitoring per ITU-T Y.1731 and TWAMP
- Y.1564 service activation testing of up to 100G at wire speed
- Supports O-RAN deployments
- Optional timing synchronization support using eSync-E, 1588v2 Master (GNSS), BC (Class C) and TC with various telecom profiles



## • E/M

### ETX-2v

Open vCPE White Box Platform



The ETX-2v includes a line of carrier-grade white boxes installed at the customer premises – either at headquarters or in remote branch sites. The ETX-2v products support a wide range of business customers and user scenarios, from small offices to large sites, using a variety of bandwidth, processing power and LAN/WAN options.

- White box appliances for virtual CPE, SD-WAN and NFV featuring powerful x86 processors
- Hardware-based security featuring a Trusted Platform Module (TPM)
- Flexible SFP/UTP connectivity with optional interfaces including: LTE, WiFi, VDSL, GPON, ETHoPDH, PWE, and more
- Supports a range of x86 CPU technologies (Rangely, Denverton and Xeon D), with flexible multi-core options
- Various memory (RAM, SSD) size options
- Intel QuickAssist technology – authentication, encryption, etc.
- SR-IOV capable ports to enhance throughput
- Fan-less, low power (~7W) options reduce carbon footprint
- Rack-mount and desktop options

### Megaplex-1

Multiservice Pseudowire Access Gateway



RAD's Megaplex-1 is a compact, highly reliable multiservice access node that transports analog and TDM traffic originating from legacy circuit-switched devices over packet switched networks (PSNs). It is specifically designed to address the needs of critical infrastructure network operators who are migrating to next-generation Ethernet, IP or MPLS communications. This includes utilities, transportation operators and government agencies. It enables seamless service migration with a scalable TDM over packet pseudowire engine and comprehensive multiservice support for PDH, high and low speed data, analog voice, and Teleprotection devices.

- Grooming and transmitting analog voice and TDM-based services over packet using standard pseudowire technology
- Wide range of services: E1/T1, FXO/FXS/E&M, IEEE C37.94, programmable serial ports and more
- Pseudowire emulation redundancy per tunnel for ultra-fast hitless restoration ensures maximum service uptime
- Bridge functionality with two optical/copper GbE uplinks and up to four FE user interface ports
- 1U 19-inch fan-less enclosure with redundant, wide-range power supply (AC/DC)

## Megaplex-4

Next-Generation  
Multiservice Access  
Node



RAD's Megaplex-4 is a carrier-class, high capacity multiservice access concentrator for delivering legacy and next-generation services over PDH/SDH/SONET and packet switched transport networks (PSN). Its ability to handle a broad range of Ethernet, data and voice services, as well as a large variety of network technologies, in a single compact managed node, makes it an ideal aggregation solution for carriers and service providers.

The device also provides a perfect fit for large enterprises, utilities and transportation companies who require an efficient way to transport and provision multiple legacy and next-generation services over their high capacity pipes. Megaplex-4 can be used as a central aggregation unit for CPEs carrying TDM and Ethernet services over various access link technologies, e.g., SHDSL and SDH/SONET.

The Megaplex-4 is available with a cable management solution to reduce storage space and handling, and eliminate cable waste.

- Modular 4U or 2U 19-inch units housing multiple I/O modules
- Carrier-class reliability with hardware, service and system redundancy
- Hardened and certified for IEEE 1613, including fan-less operation for power utilities and EN 50121-4 for railways
- Integrated MPLS switch and IP router
- MEF Carrier Ethernet 2.0-certified with traffic management, performance monitoring and Ethernet OAM
- Hybrid Ethernet and TDM architecture supporting various services up to STM-4/OC-12 and multi-GbE
- Three-tier built-in cyber security, including 802.1x and MACsec
- Non-blocking cross connect for a high volume of DS0 channels
- Built-in support for distance and differential Teleprotection for power utility applications
- Voice compression, terminal server, serial multiplexer and OMNIBUS voice conferencing modules
- Interoperability with existing TDM equipment (Nokia, Newbridge)

## MiCLK®

1588 Grandmaster on an  
SFP with Built-In GNSS



RAD's MiCLK® is the world's first Grandmaster on an SFP, allowing easy upgrades for existing base stations and backhaul equipment to support IEEE 1588 for LTE/LTE-A and 5G. Easily plugged into service routers to simultaneously distribute frequency and time, the patented MiCLK eliminates the need to install GPS/GNSS antennas at every cell site while providing highly accurate timing distribution with full network coverage – even in underground and in-building installations. It is also ideal for 4G small-cell deployments.

The field-proven MiCLK allows service providers to avoid spoofing and jamming risks, and dramatically reduces installation and engineering costs by eliminating the need for additional space or power requirements.

- Fully-featured standard IEEE 1588 Grandmaster including phase/Time of Day (ToD) to meet stringent LTE-Advanced requirements
- Built-in GNSS receiver
- Robust GNSS backup – time holdover when GNSS reception is lost, using Sync-E or 1588 frequency reference from the network (Assisted Partial Timing Support) to deliver continuous and accurate synchronization to the base station
- Miniature pluggable device fits in any standard SFP port
- Scalable solution supports up to 64 slaves

• M

**MiNID®**  
Miniature Programmable  
Network Interface Device



MiNID® is a field-programmable miniature L2/L3 network interface device (NID), available as an SFP sleeve. It features remote monitoring and fault isolation, as well as remote packet capture and micro-burst measurement capabilities.

MiNID also provides instant upgrades for legacy switches and routers to help service providers, mobile operators and wholesale carriers introduce new services quickly and with better quality of experience (QoE) while increasing operational efficiency and lowering costs.

- Easily pluggable into SFP ports of switches and routers
- Remotely managed via CLI, web interface and SNMP
- Seamlessly hosts standard FE and GbE SFP modules
- Zero-touch provisioning for fast and simple installations
- Compatible with standard fiber and copper SFPs in a variety of ranges
- Reduces inventory by reusing existing SFPs

**MiRiCi-E1/T1,  
MiRiCi-E3/T3**  
Smart SFP Ethernet to E1/T1 or  
E3/T3 Remote Bridges



RAD's MiRiCi-E1/T1 and MiRiCi-E3/T3 connect Fast Ethernet or Gigabit Ethernet LANs over framed or unframed E1 or T1 circuits, or over framed E3 or T3 links. The smart SFP miniature remote bridges provide TDM connectivity to any Ethernet device with an SFP (small form-factor pluggable) compatible Fast Ethernet or GbE port. Hot-swappable and software-configurable, the intelligent SFPs are fully managed devices supporting standard GFP encapsulation, as well as HDLC and cHDLC. They deliver a complete Ethernet over PDH solution in finger-sized SFP enclosures and enable a quick rollout of new Ethernet services over legacy TDM infrastructure. They provide simple and cost-effective alternatives to external, standalone bridge units or conversion cards for user devices, saving on space, cabling and power consumption, and simplifying management.

- Supports framed and unframed E1/T1, E3/T3
- Supports full duplex flow control
- Supports standard GFP, HDLC-like, and cHDLC encapsulation
- Fault propagation from WAN to LAN link
- Hot-insertion SFP-format plug, MSA-compliant
- Software download via TFTP
- User-configurable
- Supports Ethernet OAM per 802.3-2005 (formerly 802.3ah)
- Enhanced management of control, status and monitoring
- MiRiCi-E1/T1 Sync-E support with a unique ordering option
- Out-of-band management through I²C

## MiTOP-E1/T1, MiTOP-E3/T3 Smart SFP-Format TDM Pseudowire Gateways



RAD's MiTOP-E1/T1 and MiTOP-E3/T3 transport framed or unframed E1/T1 or E3/T3 traffic, respectively, over Ethernet, IP and MPLS networks. Featuring multi-standard pseudowire support and Synchronous Ethernet (Sync-E) in a finger-sized enclosure, the smart SFP devices provide an ideal solution for service providers, utility companies and enterprises wishing to ensure highly accurate timing synchronization for their legacy services while migrating to packet switched transport.

Part of RAD's "System on an SFP" portfolio, the MiTOP-E1/T1 and MiTOP-E3/T3 are designed for quick and simple insertion into any Fast Ethernet or Gigabit Ethernet port with an MSA-compatible socket.

- Transmits TDM-based services over Ethernet, IP or MPLS networks
- Standard pseudowire encapsulation: CESoPSN, SAToP
- Single E1/T1 or E3/T3 TDM user port
- Transparent to all signaling protocols
- Hot-insertion SFP-format plug, MSA-compliant
- Selectable clock source
- Basic management of control, status and monitoring
- Supports Synchronous Ethernet (Sync-E)
- Supports fractional E1/T1
- Supports CESoPSN CAS
- Up to eight pseudowire tunnels per E1/T1

## Optical Bypass Switch Fiber Protection Switching System



The Optical Bypass Switch is capable of automatically bypassing faulty network nodes in the event of a power outage. It is used in optical fiber communications and fits ring or linear fiber network architectures. Featuring AC or DC power supply, the Optical Bypass Switch automatically identifies the power supply status at the network node and helps avoid network outages caused by node failures.

- Small in size
- Easy installation and operation
- Low insertion loss – minimum impact on existing optical budget
- Non-latching type – automatic recovery
- LED indicators for power and optical switch status



• P

**PacketLight**  
Complete Solutions for  
WDM/OTN and Dark Fiber  
Applications Layer 1 Encryption



PacketLight's product suite offers the flexibility to build a cost-effective, highly efficient optical network infrastructure for CWDM/DWDM, OTN and dark fiber connectivity, while addressing challenges faced by service providers and organizations.

PacketLight solutions are ideal for a variety of vertical markets, such as carriers, ISPs, dark fiber providers, data centers, storage facilities, utility companies (railway and power companies), and financial institutions.

The wide range of PacketLight xWDM and dark fiber solutions includes multi-rate sub-10G CWDM/DWDM platforms, 10G CWDM/DWDM and 100G solutions with built-in OTN options, amplification and booster solutions, WSS-based ROADMs, ten 1-GbE muxponders, and passive multiplexing solutions.

- Multi-rate transponders, 2 Mbps to 200 Gbps
- Muxponder for high wavelength utilization; scales to 96 wavelengths
- Layer-1 encryption for GbE, 10-GbE, 4G FC, 8G FC, and 16G FC
- Long-distance solutions by amplification and DCM
- Performance monitoring
- Supports single or dual fiber
- Low latency connectivity
- Hot-swappable PSU (AC/DC) and fan
- Integrated management
- Compact 1U integrated devices, multi-chassis scalability
- Simple to install, maintain and configure
- Cost-effective CPE device
- Integrated OTN layer (with FEC)

**PowerFlow**  
Managed Ruggedized  
Ethernet Switches with  
Power over Ethernet

Hot Product

RAD's PowerFlow consists of managed and unmanaged industrial-grade Gigabit Ethernet switches, designed to build packet-based, PoE-intensive operational networks for critical infrastructure.

PowerFlow is ideal for OT WANs of power utilities, railways, traffic controllers, and Safe City applications requiring advanced Ethernet functionality and Power over Ethernet (PoE) support.

• **PowerFlow-2:**  
**Managed Ruggedized Ethernet  
Switches with Multiple Options**



RAD's PowerFlow-2 is a series of industrial-grade, managed Fast Ethernet and Gigabit Ethernet switches, with or without PoE support, which provide stable and reliable Ethernet transmission. Housed in ruggedized DIN rail or wall-mountable enclosures, these switches are specifically designed for harsh environments, such as industrial networking and intelligent transportation systems (ITS), as well as military and utility market applications where environmental conditions exceed commercial product specifications.

- Compact Ethernet switches with up to 16 x 10/100/1000BaseT ports, and eight x 100/1000BaseFX SFP ports
- Variety of input voltage from 12–48V DC to HVDC of 110/220V DC and support of 110/220V AC
- Variety of PoE feeding options including PoE (802.3af), PoE+ (802.3at) and PoE++ (60W)
- Flexible deployment scenarios using xSTP, ERPS (ITU-T G.8032) and ultra-fast recovery with PF-Ring/chain
- Certified for EN 50121-4, IEC 61850-3, IEEE 1613 and NEMA TS2
- Wide range of operating temperatures from -40°C to 75°C (-40°F to 167°F)





• **PowerFlow-2-10G:  
Industrial 10G Core Switch  
Demarcation/Aggregation Device**



RAD's PowerFlow-2-10G managed industrial-grade core switches provide a wide variety of reliable mechanisms for mission-critical network communications. These mechanisms include redundant and isolated power supplies, STP/RSTP/MSTP and ITU-T G.8032 Ethernet Ring Protection Switching. The PowerFlow-2-10G is a fan-less unit with IP30 ruggedized metal housing to meet the demands of industrial-grade and core layer applications.

- Industrial-grade Ethernet switches equipped with four 10G SFP+ ports
- Variety of input voltage and PoE feeding options including PoE+ with up to 400W per unit
- 19" unit with up to four 10-GbE and up to 24 GbE ports in various combinations
- Supports STP, RSTP, MSTP, ITU-T G.8032v1, G.8032v2 Ethernet Ring Protection Switching (ERPS), and PF-Ring for redundant cabling
- Environmentally hardened enclosure options

**RADinsight SD**  
Smart Diagnostics for  
Enhanced QoE

Hot Product



CSP service desk representatives are empowered with intuitive, insightful on-the-spot diagnostic tools to troubleshoot L2 connectivity issues.

RADinsight SD improves first call resolution, helping service desk representatives to easily isolate the issue and provide the customer with insightful diagnostics. It goes beyond traditional performance monitoring with intuitive end-to-end visibility across the customer LAN, CSP network (WAN) and internet/cloud.

- Cloud-based on-demand subscription service
- Dashboards display an at-a-glance, end-to-end view of connectivity path health for CSP call center personnel
- Users view diagnostics for network degradation and root cause connectivity segments based on demarcation point analytics from the edge
- QoS scores provided based on the history of a connectivity problem over time (evolution, persistence) as well as severity on top of network KPI analytics
- AI/ML-driven analytics provide insightful feedback for next best action
- Leverage EAD/NID/NTE installed base – does not require software agents or probes

• R

**RADinsight TI**  
Threat Intelligence  
at the Edge

Hot Product



RADinsight TI detects and mitigates DDoS attacks threatening CSP network and enterprise/business normal operations, utilizing an EAD/NID's unique capabilities to see all ingress and egress traffic at the CSP and customer edge, and block malicious flows.

- Cloud-based on-demand subscription service
- Protects from low-volume and short inbound attacks at carrier edges
- Protects from inbound threats from partner networks at peering points/E-Access
- Protects from outbound threats at carrier edges
- Integrates with the CSP's attack life-cycle management system

**RADview**  
Network Management  
and Orchestration

The RADview Network Management and Orchestration suite provides service providers and critical infrastructure operators a comprehensive solution for operating and managing RAD-based Ethernet and broadband access networks. It covers switches, routers, IoT gateways, virtualized network elements, multiservice gateways, and other devices in the RAD solutions portfolio.

- Network management automation through auto-discovery, zero-touch provisioning and auto-executed jobs and tasks
- Point-and-click service provisioning from planning through configuration, SLA setting and service activation test
- Real-time network status topology view and fault isolation
- SLA monitoring and reporting
- Virtually unlimited scalability for large networks support
- High Availability and Disaster Recovery
- Interoperability with third-party NMS and leading OSS/umbrella systems
- Windows and Linux support





**Intuitive, HTML5 UI/UX:**

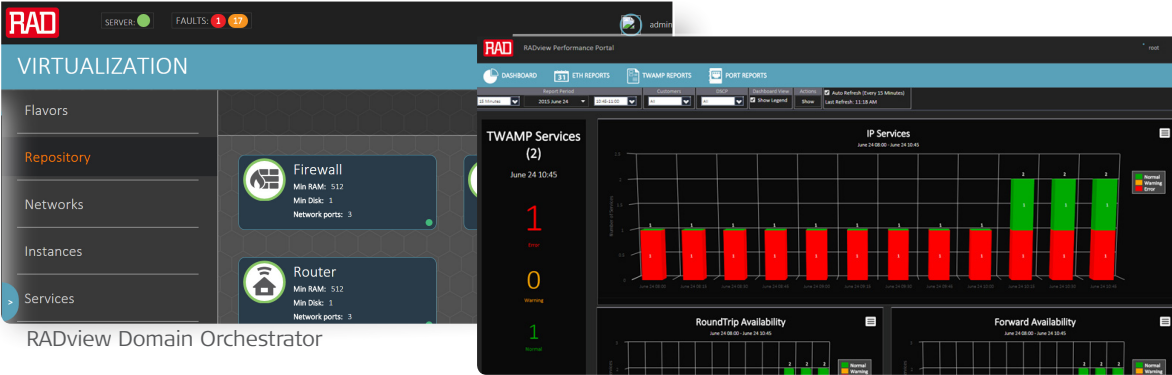

RADview Domain Orchestrator

RADview Performance Monitoring

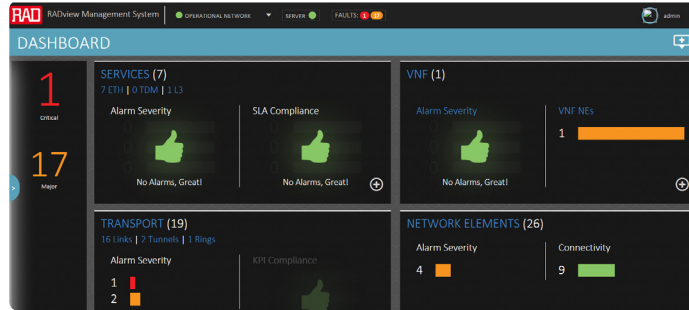

RADview Service Manager

• **RADview Performance Monitoring**



The RADview Performance Monitoring module enables ongoing monitoring of Ethernet and IP service performance by collecting KPI (key performance indicator) data from RAD devices. It allows service providers and network operators to easily monitor and manage actual network and service performance over time and compare it to service requirements and SLA (service level agreement) guarantees.

The RADview Performance Monitoring module enables immediate detection of service degradation, so that remedial actions are taken to quickly restore guaranteed performance levels. The system retrieves data lost due to connection failures and exports standard CSV ASCII files to OSS or third-party management systems.

- Collects, stores, analyzes and presents KPIs from RAD devices
- In-service bandwidth utilization measurements
- Actual performance metrics based on ITU-T Y.1731:
  - Frame delay (latency)
  - Frame delay variation (jitter)
  - Packet delivery ratio
  - Availability
- TWAMP-based L3 performance monitoring for IP services
- SLA threshold policy management
- Performance dashboard with aggregated and drill-down views
- Monthly and real-time SLA statistics reporting



# • R >>>

## • RADview Domain Orchestrator



The RADview Domain Orchestrator manages the physical and virtual resources required for effectively running vCPE services and for delivering service agility at the customer edge.

The Domain Orchestrator installs, configures and manages RAD's vCPE portfolio, as well as any x86 white box running the vCPE-OS.

In addition, it manages the VNF life cycle from onboarding new VNFs to configuring services, chaining VNFs, deploying service function chains and ongoing monitoring of live services.

Featuring a web client with state-of-the-art user interface (UI), the RADview Domain Orchestrator enables fast and easy service creation and management of value-added applications and provides a holistic view of the vCPE services.

- **NFVI management (VIM)**
- **VNF and network service onboarding**
- **Service function chain design and deployment using point-and-click UI**
- **Service maintenance (SFC backup, resource adjustment)**
- **Ongoing fault management and performance monitoring**

## • RADview Service Manager



The RADview Service Manager module is part of the RADview management suite and provides end-to-end management of MEF-based Carrier Ethernet services. An intuitive GUI, point-and-click functionality and easy-to-follow wizards facilitate planning, provisioning, monitoring, diagnostics, and SLA assurance, so that network operators can add new service offerings, as well as minimize overall operating costs, reduce provisioning times and maximize the efficiency of the entire network.

- **Offline resource optimization and capacity planning simplifies pre-deployment stages**
- **Point-and-click end-to-end service provisioning and OAM settings**
- **Automatic correlation of network faults with impacted services and customers**
- **Security management supporting user access profiles and allowing network partitioning**
- **Graphic representation of network clouds, links, nodes, end-to-end services, and network status indication**
- **UI designed for management of very large networks**

## RADWIN Fiber In Motion

Mobile Wireless Access for Transportation Communications



# RADWIN

RADWIN's mobile wireless radios for transportation communications ensure continuous high speed wireless connectivity between trains or metros and network control and data centers. They deliver the highest throughput for on-board communications with guaranteed bandwidth to each railway vehicle, even on subways and monorail lines. RADWIN's radios offer bi-directional and asymmetrical train-to-track bandwidth with per-train quality of service (QoS) guarantees. This allows always-on communications between trains and control and operations centers for critical services such as information displays, panic buttons, PTT (push-to-talk), telemetry, ticketing machines, and video streaming. They are fully compliant with railway environmental standards, which are a prerequisite for all equipment installed on railways and metros. RADWIN's field-proven mobile wireless access devices are deployed worldwide, powering applications such as broadband WiFi for passengers, real-time high-definition CCTV, PIS, CBTC and more. Operating in challenging outdoor conditions and in underground tunnels, they deliver unmatched capacity and long-range coverage.

- Coverage range of 11 km (6.8 miles)
- Integrated WiFi access point (802.11b/g/n) for video transmissions
- Built-in GPS for vehicle tracking
- Direct DC power from the vehicle (10–36V DC), power consumption <25W
- Up to 750 Mbps total available throughput from the base station
- Up to 250 Mbps total available throughput for vehicle/vessel subscriber units
- SNMPv3
- AES 128
- IP67 rating for severe outdoor conditions

## RIC-LC

Ethernet Converter for Multiple PDH Circuits



RAD's RIC-LC is a Fast Ethernet over E1 converter that provides simple, efficient and cost-effective Ethernet connectivity over up to 16 bonded E1 links. As an Ethernet converter for multiple PDH circuits, the RIC-LC enables service providers to supply high capacity Ethernet services to remote locations over existing TDM infrastructure. Deployed in point-to-point or hub-and-spoke topologies, it operates opposite Ethernet over TDM demarcation devices and aggregators as well as opposite third-party gateways that support Ethernet over NG-PDH encapsulation and bonding techniques.

The RIC-LC is an ideal solution for Ethernet Private Line and Ethernet Private LAN services, inter-office connectivity, and IP DSLAM, IP Node B backhaul over PDH access networks.

- Up to 16 E1 network interfaces
- Four Fast Ethernet UTP/SFP user ports
- GFP (G.8040), VCAT (G.7043), LCAS (G.7042)
- VLAN-aware and VLAN-unaware bridging; VLAN stacking
- Four QoS levels; SP and WFQ scheduling; CIR (committed information rate) support
- Remote and local, inband and out-of-band management
- Dual in-line package (DIP) switches for activating diagnostic loopback tests
- TDM to Ethernet fault propagation

## • R

## ROC-19, ROC-19L Outdoor Cabinets



ROC-19 and ROC-19L are self-contained outdoor cabinets for housing different RAD indoor devices for various outdoor telecom services. Constructed for outdoor use, the enclosures are powered from an AC or DC power source and are ideal for service providers that require efficient environmental isolation for their equipment.

The ruggedized IP56 (ROC-19) and IP66 (ROC-19L) NEMA-4-rated construction includes a rain hood, offering full shielding and protection against dust, rain and ice. Efficient ventilation is assured by an intake fan with replaceable air filters (ROC-19) or passive convection (ROC-19L). Secure, efficient maintenance and access are offered by a 2-point (ROC-19L) or 3-point (ROC-19) door locking mechanism, as well as an integrated fiber cable splicer/guide system, intrusion detection and over-current protection.

- Outdoor cabinet for indoor devices, with integrated fiber splicer and guides
- IP56/66 NEMA-4-rated metal enclosure
- DC or AC powered
- Effective grounding and over-current protection
- Optional surge protection for copper ports
- 2- or 3-point door locking
- Intake fan with replaceable filters, or passive cooling
- Wall or pole mounting options

## SecFlow-1p Ruggedized IIoT Gateway

Hot Product



The compact SecFlow-1p is an entry-level multiservice gateway for cost-effective industrial IoT backhaul. Housed in a ruggedized enclosure, it allows secure connectivity over wireless or fiber networks for all types of industrial devices, including RTUs and smart meter aggregation devices. SecFlow-1p is for power utilities IEC 61850-3 and IEEE 1613, as well as for oil and gas hazardous environments (Class 1, Division 2).

- Hosts third-party software using Docker container technology
- Multiservice support: GbE copper and fiber, serial RS-232/485
- Single or dual cellular modem 2G/3G/4G/5G/PLTE, 450-MHz, Anterix, CBRS; dual SIM for always-on connectivity
- WiFi, WiFi HaLow and LoRaWAN connectivity
- Dynamic routing with OSPF, BGP, VRF and secure VPN using IPsec, DMVPN and NAT for flexible connectivity
- Cyber security suite: TPM 2.0, secure boot, 802.1X, IPsec encryption with automated PKI, stateful firewall
- Serial protocol handling with transparent tunneling/protocol conversion/terminal server for IEC 60870-5-101, IEC 60870-5-104, Modbus RTU to Modbus TCP, and DNP3.0 RTU to TCP
- Zero-touch provisioning, firewall configuration, fault management and reporting, bulk software upgrade, and database management using RADview

## SecFlow-1v

Ruggedized Multiservice IloT Gateway with PLC and PoE, US-Certified

Hot Product



The compact SecFlow-1v is a ruggedized multiservice gateway, featuring built-in security mechanisms designed for applications controlling mission-critical operations. It is ideal for industrial IoT backhaul, enabling fast, secure and economical deployment of new IoT sites. Allowing secure connectivity over wireless or fiber networks – either public (e.g., cellular) or private – it connects all types of industrial devices, including RTUs, smart meter aggregation devices, IoT base stations or concentrators, CCTV cameras, point-of-sale devices, WiFi base stations, and more. RADview's security information and event management (SIEM) enables collection of all security events detected in the network. The system collects events from SecFlow devices and displays them visually on customizable dashboards.

SecFlow-1v provides reliable and secure Layer 3 communications for power utilities, water and gas utilities, public safety and homeland security agencies, as well as intelligent transportation operators.

- **Hosting of third-party software using LXN container technology**
- **Multiservice support: GbE copper and fiber, serial RS-232/485, Power over Ethernet (PoE)**
- **Single or dual cellular modem for a 2G/3G/4G/CBRS/Anterix B8 uplink, dual SIM**
- **WiFi connectivity as access point**
- **Dynamic routing with OSPF, BGP, VRF and secure VPN using IPsec, DMVPN and OpenVPN for flexible connectivity**
- **Cyber security suite: 802.1X, IPsec encryption with automated PKI, stateful firewall**
- **Serial protocol handling with transparent tunneling/protocol conversion/terminal server for IEC 60870-5-101, IEC 60870-5-104, Modbus RTU to Modbus TCP, and DNP3.0 RTU to TCP**
- **Zero-touch provisioning, firewall configuration, fault management and reporting, bulk software upgrade, and database management using RADview**
- **Digital and analog IOs with integrated RTU/PLC functionality**
- **LoRaWAN gateway for remote sensors aggregation**
- **Complies with IEC 61850-3, IEEE 1613 and EN 50121-4**

## SecurityGateway

VPN Aggregator, Router and Firewall



SecurityGateway is a major building block of RAD's industrial IoT solution, serving as a state-of-the-art VPN aggregation appliance. In the fast growing market of IloT and the need for secure communications, SecurityGateway provides a small form-factor yet powerful and cost-effective solution for aggregating traffic from multiple remote IloT sites.

SecurityGateway aggregates multiple VPNs from remote SecFlow devices and addresses industrial IoT applications, for example:

- Distributed automation in secondary substations
- Smart meter concentration
- Water resources management
- Smart retail

Typically located behind the organizational firewall, SecurityGateway may also serve as a WAN gateway, depending on customer needs. RADview's security information and event management (SIEM) enables collection of all security events detected in the network. The system collects events from SecFlow devices and displays them visually on customizable dashboards.

- **Compact 19" 1U VPN aggregation device supporting L2/L3 VPNs**
- **Optional high availability**
- **Feature-rich, dual stack IPv4/IPv6, including static and dynamic routing and NAT**
- **Stateful firewall, IKE1 and IKE2, automated PKI (X.509) with integrated DNS resolver**
- **Supports flexible connectivity methods such as encrypted IPsec VPN, OpenVPN and L2TP**
- **User authentication using RADIUS**
- **L2 functionality**
- **User-friendly, easy-to-use web-based GUI**
- **Fault management and reporting using RADview**

A

B

C

D

E

F

G

H

I

J

K

L

M

N

O

P

Q

R

S

T

U

V

W

X

Y

Z



• S

**SFP/XFP/SFP+/QSFP+/QSFP28 Transceivers**  
Small Form-Factor Pluggable Transceivers



RAD's SFP/XFP/SFP+/QSFP+/QSFP28 small form-factor pluggable transceivers are hot-swappable, input/output transceiver units converting optical and electrical media. Providing a wide range of detachable interfaces to multimode/single-mode optic fibers and UTP/coaxial electrical cables, RAD's miniature transceiver units enable significant savings in system maintenance and upgrade costs, as well as facilitate efficient design of host devices and flexible network planning.

It is strongly recommended to order RAD devices with original RADs SFP/XFP/SFP+/QSFP+/QSFP28 transceivers installed to ensure that the entire assembled unit has undergone comprehensive functional quality tests. RAD cannot guarantee full compliance to product specifications for units using non-RADs SFP/XFP/SFP+/QSFP+/QSFP28 pluggable transceivers.

**Optical SFPs**

- **MSA (multi-source agreement) compliant**
- **Built-in DDM (digital diagnostic monitoring) function**

**Smart SFPs**

- **GPON OLT in an SFP**
- **XGS-PON OLT in an SFP+ (10G symmetric)**

- A
- B
- C
- D
- E
- F
- G
- H
- I
- J
- K
- L
- M
- N
- O
- P
- Q
- S
- T
- U
- V
- W
- X
- Y
- Z

**vCPE-OS**  
Open Carrier-Class Operating System for Network Edge Virtualization

Hot Product



The Linux-based, carrier-class vCPE-OS runs on any white box server and is pre-loaded in RAD's virtual CPE (vCPE) platforms. It combines powerful networking capabilities with virtualization for hosting and accelerating SD-WAN and any other value-added virtual network function (VNF) applications from any vendor.

- **Slim, high performance operating system for optimized vCPE**
- **Open solution, compatible with any VNF (networking, security and IT), orchestrator and SDN controller**
- **Any access with advanced transport/networking capabilities: LTE, WiFi, Carrier Ethernet, xDSL, PON, and TDM**
- **High Availability: performance monitoring, troubleshooting and self healing – TWAMP, ICMP Echo, UDP Echo**
- **Any hardware: RAD's white box/gray box platforms, third-party servers, and RAD's pluggable PNFs**
- **Comprehensive management and security suite**
  - NETCONF/YANG, CLI, Syslog, alarms, and more
  - SNMPv3, SSH, SFTP, Access Control, TACAS+, RADIUS
  - Zero-touch and call-home provisioning

# RAD Services





## RAD Global Services

### Peace of Mind, Where and When You Need It

---

RAD solutions enable service providers and network operators to deliver the best possible service experience and seamlessly migrate to next-generation networks – all while increasing operational efficiency and reducing TCO.

RAD Global Services is dedicated to assisting our customers in maximizing the benefits of our solutions. Our team provides real-time service guidance, comprehensive planning, and proactive maintenance to ensure optimal performance.

RAD Global Services provides expert consulting, troubleshooting assistance, online tools, regular

training programs, and various equipment coverage options – all designed to enable seamless installations and faster service rollouts. Moreover, our RAD programs help service providers to meet their SLAs and avoid penalties, while private network operators can rely on full support for their mission-critical applications.

These vital services are available from authorized RAD partners. They are backed by highly dedicated and professional teams at regional technical assistance centers, together with project management staff and international training professionals.



## RADcare Technical Support

### Partner Benefits

- Strict service level agreements (SLAs): Receive response, restore service and resolve issues within a known and guaranteed time frame
- Move to the head of the queue with priority handling by RAD support centers and round-the-clock access to RAD's experts
- Free access to RADcare Online, including regular software updates, patches, online/remote configuration assistance and RAD's FAQ knowledge base

### Customer Benefits

- Ensure optimal quality of experience for your customers by maintaining a high quality network
- Meet your SLAs and avoid penalties by minimizing service outages and enabling fast recovery
- Plan ahead to limit your spending on support and eliminate hardware repair costs related to old equipment
- Shorten time to market (TTM): Rely on RADcare to support your operations so you can turn up new services faster

# RAD Global Services



- Guidance throughout design and rollout
- High- and low-level network design
- Support service migration and network upgrades
- On-site services
- Consulting services



- Project coordination
- Single point of contact
- Periodic meetings and progress reports
- Project-specific documentation



- Training-on-demand
- Regional sales, pre-sales and technical seminars
- RAD certification



- Strict SLA commitments on response, service restore and resolution times
- 24x7 support, priority handling and escalation procedures
- RADcare Online portal for software updates and upgrades
- Optional multi-year blanket coverage



## Project Assured Services

RADpro Project Assured services encompass all relevant aspects of the pre-installation design and rollout stages to get the new network up and running as quickly as possible. In addition, running seamlessly along with providing added vital benefits.

RADpro Project Assured services include the following valuable elements:  
**Planning • Staging • Site Survey • Equipment and Management Installation • Acceptance Testing and Commissioning • Resident Engineer**



## Project Assured Services

Enjoy full project assured service led by certified RAD engineers who are committed to your project's success from start to finish. RAD offers different project assured packages which include:

- High-level design (HLD): Thorough review of the physical topology, required hardware and software, and network management
- Low-level design (LLD): A definitive reference for system and network implementation, including detailed configuration instructions for devices, network management system and interfaces
- Configuration and testing performed by RAD experts to ensure ideal turn-up time
- Full documentation of your system's installation requirements for easier maintenance and future changes
- Commissioning design and execution so that the entire network can be certified before signing off



## Project Management

RAD's professional Project Management staff ensures that your project will have a timely and smooth implementation from the planning stage through completion.

- A single point of contact (Project Manager) within RAD supervises all logistical, technical and commercial aspects of the implementation of all network solutions under your contract
- Periodic status meetings
- Detailed project plan procedures and documentation, regular progress reports, and management of all project aspects



## Training Center

RAD's training programs are designed to keep your team up-to-date with the latest RAD solutions.

- Technical seminars, web-based training and project-based training: A variety of on-site and remote interactive training options to ensure your engineers master your RAD equipment
- Course materials include a carefully balanced mix of lecture, demonstration and hands-on experience
- Topics include theory, configuration and troubleshooting



**RADadvantage**  
*Partners Program*



# Welcome to the RADadvantage Partners Program

---

Commitment. Trust. Respect. Partnership. These are just some of the values that comprise the essence of RADadvantage, RAD's channel partner program. Ultimately, the success of a partnership is measured by the benefits that are enjoyed by all parties:

The vendor, its partners, and their respective end-users. That's why RAD places immense importance on its network of channel partners and invests significantly in partner enablement, engagement, and support.

## Shared Interests and Commitments

---

RAD and its channel partners embrace a set of fundamental guiding principles:

- Delivering the highest quality products, solutions and services that create loyal end-users
- Maximizing customer satisfaction
- Conducting business where there is trust and respect
- Resolving problems with candor and good judgment
- Cooperating to win new business and improve existing opportunities

## RADadvantage Program Highlights

---

The RADadvantage Partners Program is designed to incrementally reward partners based on achievements in annual revenues, service level accreditation, and commitment. Designated partnership levels are reviewed and adjusted annually.

RADadvantage Partners enjoy benefits such as:

- Joint business development efforts
- Online and face-to-face sales and technical training programs
- Support for co-branded marketing activities
- Official acknowledgement of Partner relationship



## RAD's LMS Solution for Partners

RAD recognizes the importance of continuous learning and skill development to create a successful partnership. Therefore, we introduced the Learning Management System (LMS), which assists in elevating our partners' capabilities and fosters collaborative growth.

Our LMS solution is a strategic tool for RAD partners to enhance their knowledge, streamline processes, and stay ahead in an ever-evolving market.

### »Key Features Delivering Added Value

- **Tailored learning paths**, allowing partners to focus on the skills and knowledge most relevant to their business goals.
- **Real-time progress tracking**, allowing partners to monitor and analyze the progress of their teams in real-time. This also provides valuable insights into areas that partners may want to know more about.
- **Comprehensive analytics and reporting**, offering partners a deep understanding of their team's learning outcomes.
- **Ease of integration** with existing systems ensures a smooth transition to our LMS solution. This minimizes disruption and allows partners to leverage the benefits of our platform without major operational overhauls.

### »Transformative Impact on Partnership Success

- **Skill enhancement:** Partners can upskill their teams, ensuring they are equipped with the latest industry knowledge and trends. This gives partners a competitive edge in the market.
- **Increased efficiency:** Streamlined training processes reduce the time and effort required for onboarding and ongoing education. This translates into improved productivity and quicker response times to market demands.
- **Collaborative growth:** RAD's LMS fosters a culture of continuous learning and collaboration.

RAD's LMS solution is not just about technology; it's a commitment to nurturing strong, informed, and agile partnerships. By investing in the continuous learning journey of our partners, we are investing in a shared future of innovation, growth and success.

» For more information, please contact [training@rad.com](mailto:training@rad.com)



Your Network's Edge®

## RAD Headquarters

### North American Headquarters

900 Corporate Drive, Mahwah, NJ 07430, USA

Tel 1-201-529-1100 | Toll free 1-800-444-7234 | Fax 1-201-529-5777

Email [market@radusa.com](mailto:market@radusa.com)

### International Headquarters

24 Raoul Wallenberg Street, Tel Aviv 6971923, Israel

Tel 972-3-6458181

Email [market@rad.com](mailto:market@rad.com)

[www.rad.com](http://www.rad.com)

Specifications are subject to change without prior notification. The RAD name and logo are registered trademarks of RAD Data Communications Ltd. RAD product names are trademarks of RAD Data Communications Ltd. ©2024 RAD Data Communications. All rights reserved. Catalog number 802756, Version 01/24